

GENERAL INFORMATION

SECTION I

SST-6 MODELS

GEAR	1362-A		PS130-6B, 1362-B		1362-C, 1364-C		PS0140-6A, 1463-A	
	RATIO	% STEP	RATIO	% STEP	RATIO	% STEP	RATIO	% STEP
1	8.53	54	8.53	75	8.86	75	7.47	83
2	5.52	55	4.87	62	5.06	62	4.08	80
3	3.57	57	3.00	58	3.12	58	2.26	82
4	2.27	50	1.90	43	1.97	43	1.24	24
5	1.51	51	1.33	33	1.38	38	1.00	19
6	1.00		1.00		1.00		.84	
REV.	8.53		8.53		8.86		7.47	

SHIFT PATTERN PS130-B, 1362-A, B, C, 1364-C SST-6 SPICER®

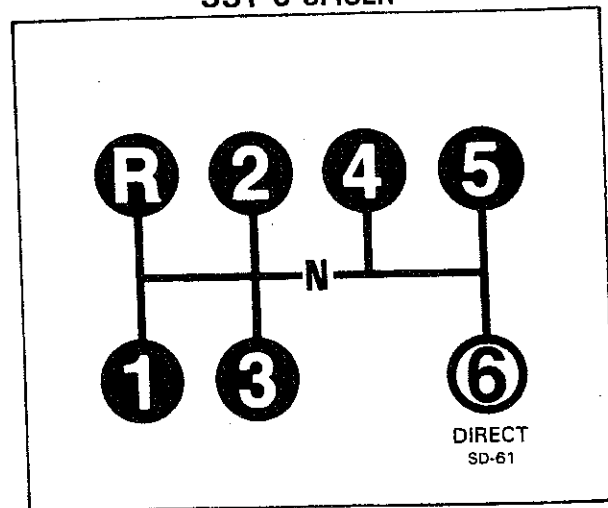

SPECIFICATIONS

- Speeds 6 Forward, 1 Reverse
- Torque Capacity . . . 950 - 1400 lbs. ft.
(1290 - 1896 Nm)
- Length 28 1/8" (715 mm)
- Weight Iron 545 lbs. (247 Kg)
Aluminum 465 lbs. (211 Kg)
- End Yokes 1710 6-4-5351
1760 6.3-4-41
1810 6 1/2-4-3021
- Flanges 1710 6-1-4881, 6-1-5351 (Metric)
1810 6 1/2-1-1991, 6 1/2-1-2151 (Metric)
- Clutch 14" or 15 1/2" (356.6 or
393.77 mm) 2-Plate
- Clutch Housing S.A.E. Nos. 1 or 2
(Both Available with Nodal Mount)
- Oil Capacity 41 Pints (19.4 Liters) at 0° Installation
- Drive Gear 2" Standard, 1 1/4" Optional
- Power Take-Off 6 Bolt right and 8 Bolt lower left.
Countershaft P.T.O. provisions,
standard on the right side,
optional on the left.

PS0140-6A, 1463-A SST-6 SPICER®

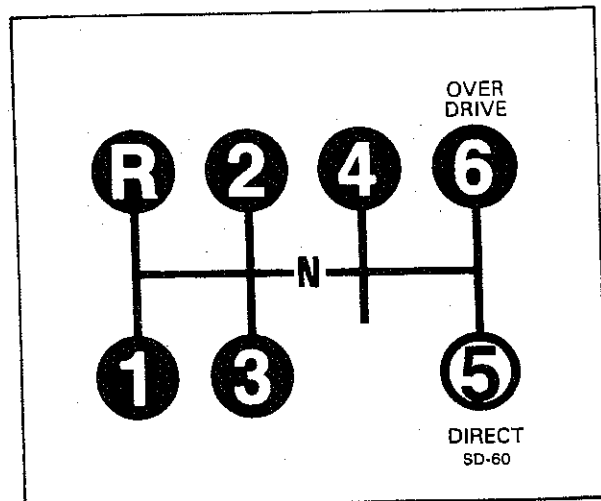

OPERATION

How to Shift the Spicer SST-2 6 SPEED

Starting

With the engine idling, depress the clutch and move stick into first gear. Gradually release the clutch and accelerate the engine to governed speed (2100 RPM).

NOTE

A clutch brake is used to stop gear rotation to complete a shift into first or reverse when the vehicle is stationary. If a butt-toothed condition exists between the clutching teeth, a momentary re-engagement of the main clutch will allow the gear train to move into a smooth engagement.

NOTE

The clutch brake on this transmission is actuated by depressing the clutch pedal all the way to the floor. For normal upshifts and downshifts, only a partial disengagement of the clutch is necessary to break engine torque.

Upshifting

Once governed engine speed has been attained, to shift into second gear, depress the clutch and move the stick to neutral. Engage the clutch and allow RPM to drop approximately 750. (RPM drop may vary with engines of different governed speeds)*, depress the clutch and move the stick into second gear. Re-engage the clutch and accelerate to governed speed. Continue upshifting through sixth gear in this manner.

Downshifting

When downshifting from sixth gear, allow RPM to drop approximately 750*, depress clutch pedal and move stick to neutral. Engage the clutch, accelerate to governed speed, depress the clutch and move the stick into fifth gear then re-engage the clutch. Continue downshifting through first gear in this manner.

***NOTE**

All RPM drops are based on the 1362-A transmission ratios and an engine governed speed of 2100 RPM. These drops will vary with other transmission ratios or with engines of higher governed speeds.

Spicer® Transmission Lubrication

To insure proper lubrication and operating temperatures in these units, it is important that proper lubricants be used and correct oil levels be maintained.

Recommended Lubricants

The lubricants listed below are recommended, in order of preference, for use in all Spicer mechanical transmissions, auxiliaries and transfer cases.

DO NOT USE EXTREME PRESSURE ADDITIVES, such as found in multi-purpose or rear axle type lubricants. These additives are not required in Spicer transmissions, and in some cases may create transmission problems. Multi-purpose oils, as a group, have relatively poor oxidation stability, a high rate of sludge formation and greater tendency to react on or corrode the steel and bronze parts.

Oil Changes

Many factors influence the following oil change periods. Therefore, a definite mileage interval is not specified here. In general, however, it is suggested that a drain and flush be scheduled every 1 year/100,000 miles (160,900 km) for mineral, 5 year/500,000 (804,500 km) for synthetic for normal over-the-highway operations. Off-highway uses usually require an oil change every 1000 hours. The oil level in the transmission should be checked every 5000 miles (8045 km) on-highway, or every 40 hours in off-highway operations. When it is necessary to add oil, we recommend that types or brands of oil not be mixed. The correct oil level in *all* Spicer transmissions is established by the filler plug opening.

Refill

First, remove all dirt around the filler plug. Then refill the transmission with new oil. Use the grade recommended for the existing season and prevailing service. The lubricant should level with the oil fill plug located on the right side of the transmission case.

Overfilling

Do not overfill the transmission. This usually results in oil breakdown due to excessive heat and aeration from the churning action of the gears. Early breakdown of the oil will result in heavy varnish and sludge deposits that plug up oil ports build up on splines and bearings. Oil overflow escapes onto the clutch or parking brakes, causing additional trouble.

Towing

Do not tow vehicles equipped with Spicer transmissions without first pulling the axles or disconnecting the drive shaft. Lubrication of the internal gear train is inadequate when the vehicle is towed.

Non-Synchronized (PS Models)

<u>Temperature</u>	<u>SAE Grade</u>	<u>Class/Type</u>
All	SEA 50	Synthetic Transmission oil Spicer Specification MS-961-T
Above 0°F	50	HD Engine Oil Mil-L-2104D or E
Below 0°F	30	API-CD, CE, SF or SG Cat TO-4
Above 0°F	80W-90	Automotive Gear oil
Below 0°F	75W	API MT-1

EP gear oils are not recommended for operating temperatures above 230°F.

Do not mix engine, transmission or gear (axle) lubes.

Synthetic SAE 50 required for Applications above 399 Horsepower.

General Precautions for Disassembly

IMPORTANT

Read this section before starting the detailed disassembly procedure.

Follow each procedure closely in each section, making use of both the text and the pictures.

Rebuild Facilities

A suitable holding fixture or overhaul stand is desirable but not necessary to rebuild this unit. The flat bottom of the transmission case provides a suitable working platform when the unit is placed on a sturdy shop table.

For easier working conditions, table height should be 28-30 inches. A light chain hoist should be used to handle the mainshaft and countershafts during removal and reassembly procedures.

Cleanliness

Transmissions should be steam cleaned prior to disassembly. Seal all openings before steam cleaning to prevent entry of dirt and water which can damage serviceable parts.

Dirt is abrasive and will cause premature wear of bearings and other parts. We suggest that mechanics have a small wash tank to clean parts just prior to reassembly.

Bearings

When a transmission is removed at relatively low mileage, bearings should be removed with pullers designed for this purpose. Wrap the bearings to keep out dirt. Clean, inspect and lubricate all bearings just prior to reassembly. If accumulated mileage is over 150,000 miles, we suggest that all bearings be replaced.

End Yokes & Flanges

Hammering on end yokes and flanges, to remove or install them is not only destructive to the yoke or flange itself, but can also cause serious internal damage. Hammering destroys or mutilates the pilot diameters and warps or bends the flange. Hammering on end yokes will close-in the bearing bores or misalign yoke lugs and result in early failures of journal needle bearings, etc.

Serious damage can be done internally to bearings, thrust faces and washers, pilot bearings, etc., by hammering on external parts.

In most designs when the yoke/flange locknuts are tightened and secure, the internal bearings and gears are in proper location. When the yoke/flange is driven on the shaft, two conditions can exist.

- (a) If the bearing fit is *tight* on the shaft, then usually the bearings will brinell as they must absorb the pounding forces.
- (b) If the bearing is *loose*, the shaft will keep moving inward until it is stopped by the internal parts such as pilot bearing thrust washers, etc.

Tool Reference

Tools

Spicer Transmissions can be repaired with ordinary mechanic's hand tools, however this procedure is not only time consuming but could damage otherwise reusable

parts. To reduce maintenance costs and vehicle downtime, we recommend using the special tools shown in this section.

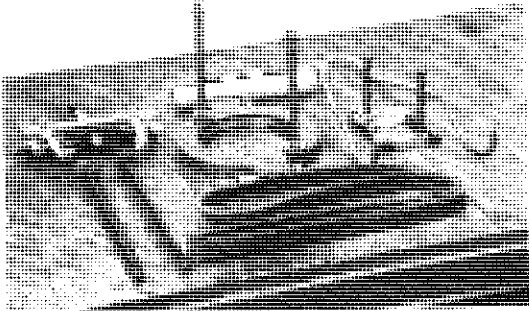

Suggested pullers and alignment tools.

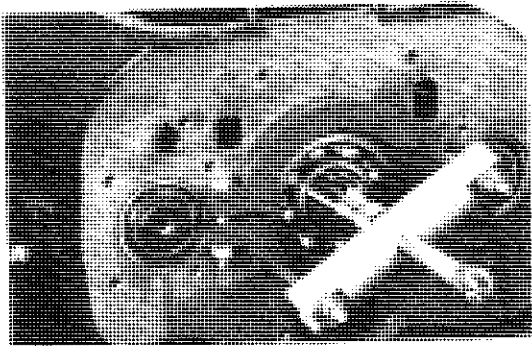

Reversible input and output bearing puller—(Kent Moore J 24348). Used with end yoke remover (J 7804-01).

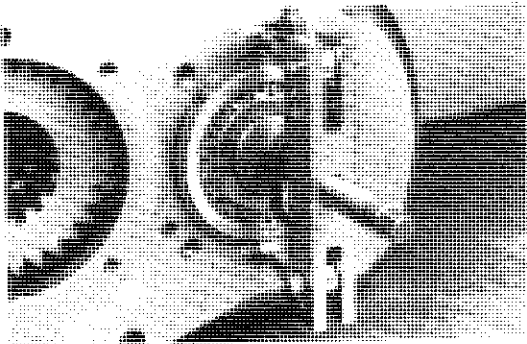

Countershaft front bearing puller (Snap-on—CJ 80).

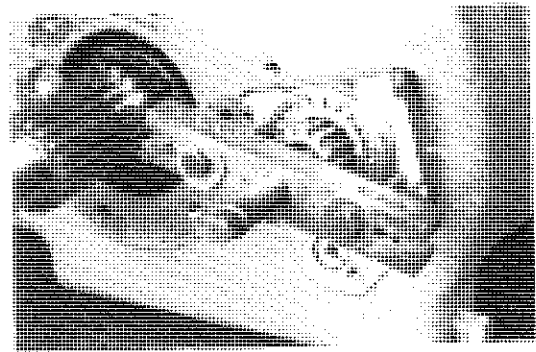

Countershaft rear bearing puller (Snap-on—CJ 950).

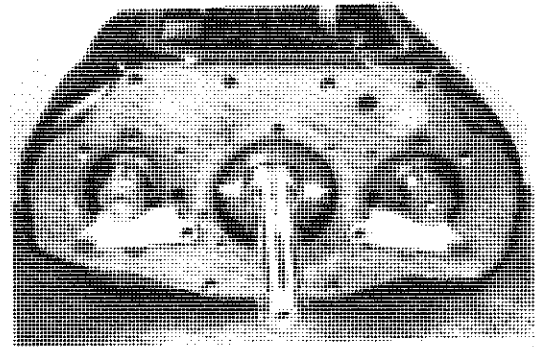

Countershaft alignment blocks—Kent Moore (J 28720). Provides maximum clearance for mainshaft assembly installation. Allows countershafts to be rotated for timing purposes.

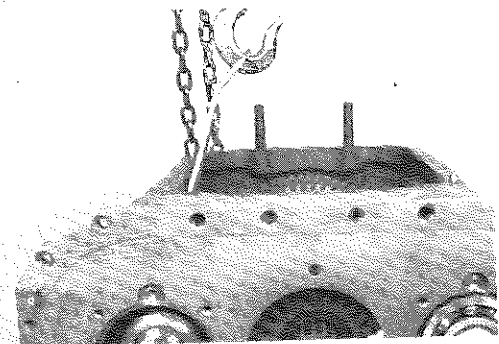

Countershaft lift hook—(Kent Moore J 23667). Holds countershaft in time while centering the countershaft in the case bore for easier bearing installation.

Tools may be purchased thru:

Kent-Moore
Tool Division
29784 Little Mack
Roseville, Michigan 48056
Telephone: 313-774-9500

Overhead Control

Disassembly

1. Remove the six retaining capscrews and lockwashers. Separate the dome from the shifter housing and gasket and lift straight up.
2. Position shift lever dome on edge in vise.
3. Pull up grommet. Depress collar against spring and remove lock pin.
4. Slide the compression cup up shift lever and remove rock shaft snap ring.
5. Tap rock shaft free of dome and remove shift lever. Remove seal and discard.
6. Remove shift lever handle and slide grommet, collar, spring and cup off lever.

4. Assemble rock shaft snap ring to groove of dome and lock rock shaft in place.
5. Grease lightly and assemble new seal to shift dome. Grease inner wall of cup and slide over lever into position on dome.
6. Assemble spring, collar and grommet over shift lever. Depress collar and insert lock pin through hole in lever.
7. Assemble shift lever handle.
8. Place shift lever and dome assembly on shifter housing with gasket, noting that finger enters the neutral position notches.
9. Secure with six capscrews and lockwashers.

Inspection

Wash all parts thoroughly and inspect for excessive wear at cross hole in lever and rock shaft. Inspect finger end of lever for excessive wear.

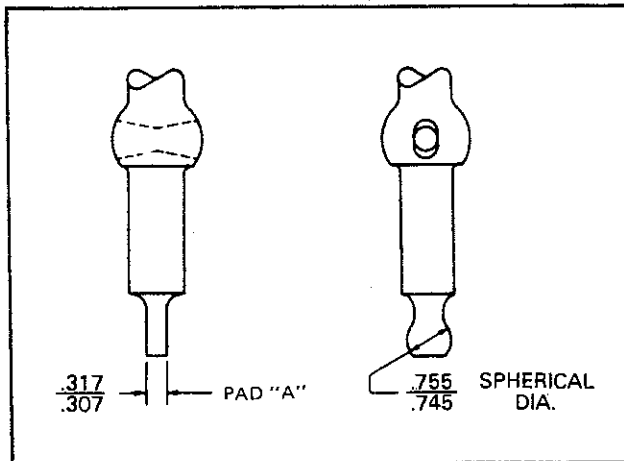

Check spring tension by comparing to a new part.

Reassembly

1. Position shift lever dome on edge in vise.
2. Hold shift lever so that cross hole in lever aligns with rock shaft cross holes in dome.
3. Insert rock shaft through hole in dome and cross hole of shift lever.

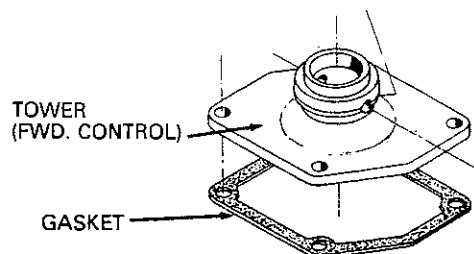

SHIFT LEVER AND TOWER ASSEMBLY

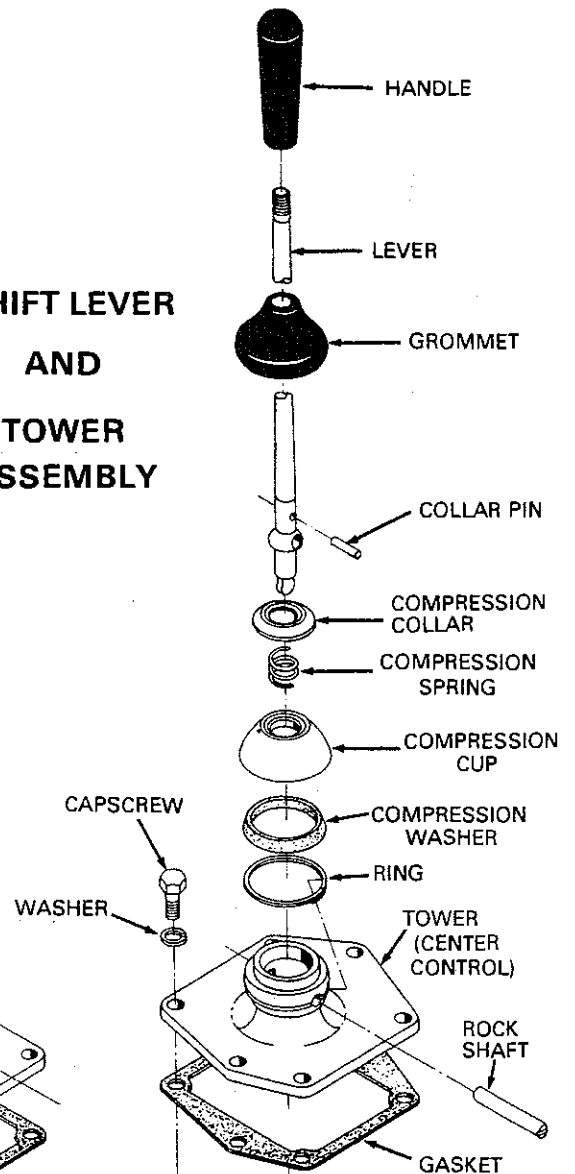

Remote Control Assembly

Disassembly

Remove six capscrews and lockwashers and separate the remote control from the shifter housing.

1. Remove set screw from universal joint assembly and pull universal joint from the rod.
2. Remove four capscrews and lockwashers holding end cover and gasket in place.
3. Remove set screw from joint shift rod finger and tap rod through cross holes in housing.
4. Remove finger from housing.
5. Remove set screw from inner shift finger.
6. Slide rod and bracket assembly from inner shift finger.
7. Be careful not to lose key from rod or shift finger.
8. Remove seals from cross holes in housing.

Inspection

Check shift fingers for excessive wear. Check all bores and rods for excessive wear or scuffing.

Clean parts thoroughly and apply light coat of grease to pivot points when reassembling.

Assembly

1. Install new key in rod and bracket assembly and install into remote housing, sliding shift finger (inner) on end of rod.
2. Line up set screw hole and install set screw, and torque 40 to 50 lbs. ft.
3. Install joint shift rod through cross holes and through outer finger, making sure finger is inserted into bracket.
4. Align set screw hole and install same, and torque 40 to 50 lbs. ft.
5. Install end cover and secure with four capscrews and lockwashers.
6. Install two new oil seals in joint shift rod bores.
7. Install joint assembly and secure with set screw.

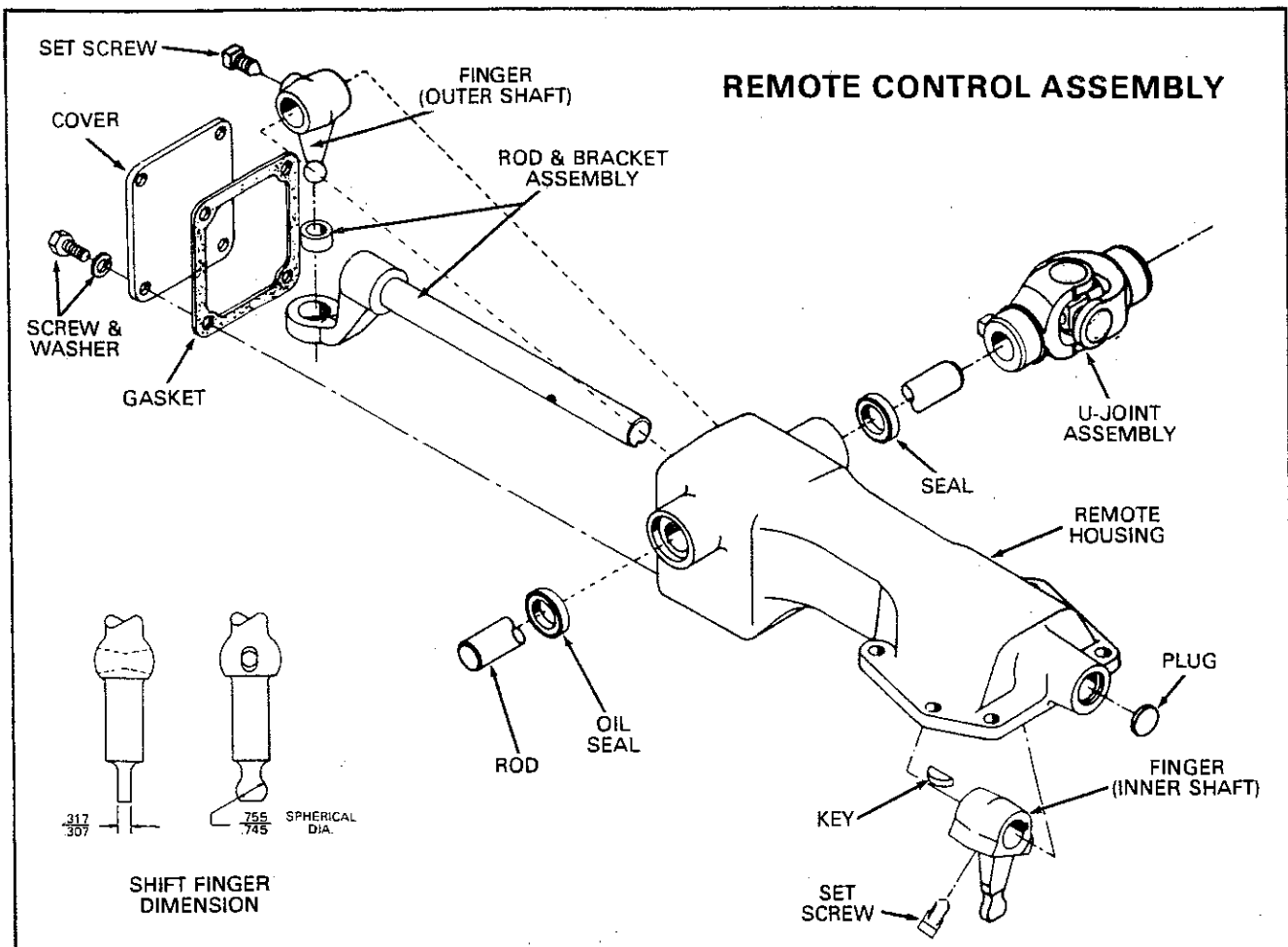

SHIFTER HOUSING FORWARD CONTROL

SECTION IV

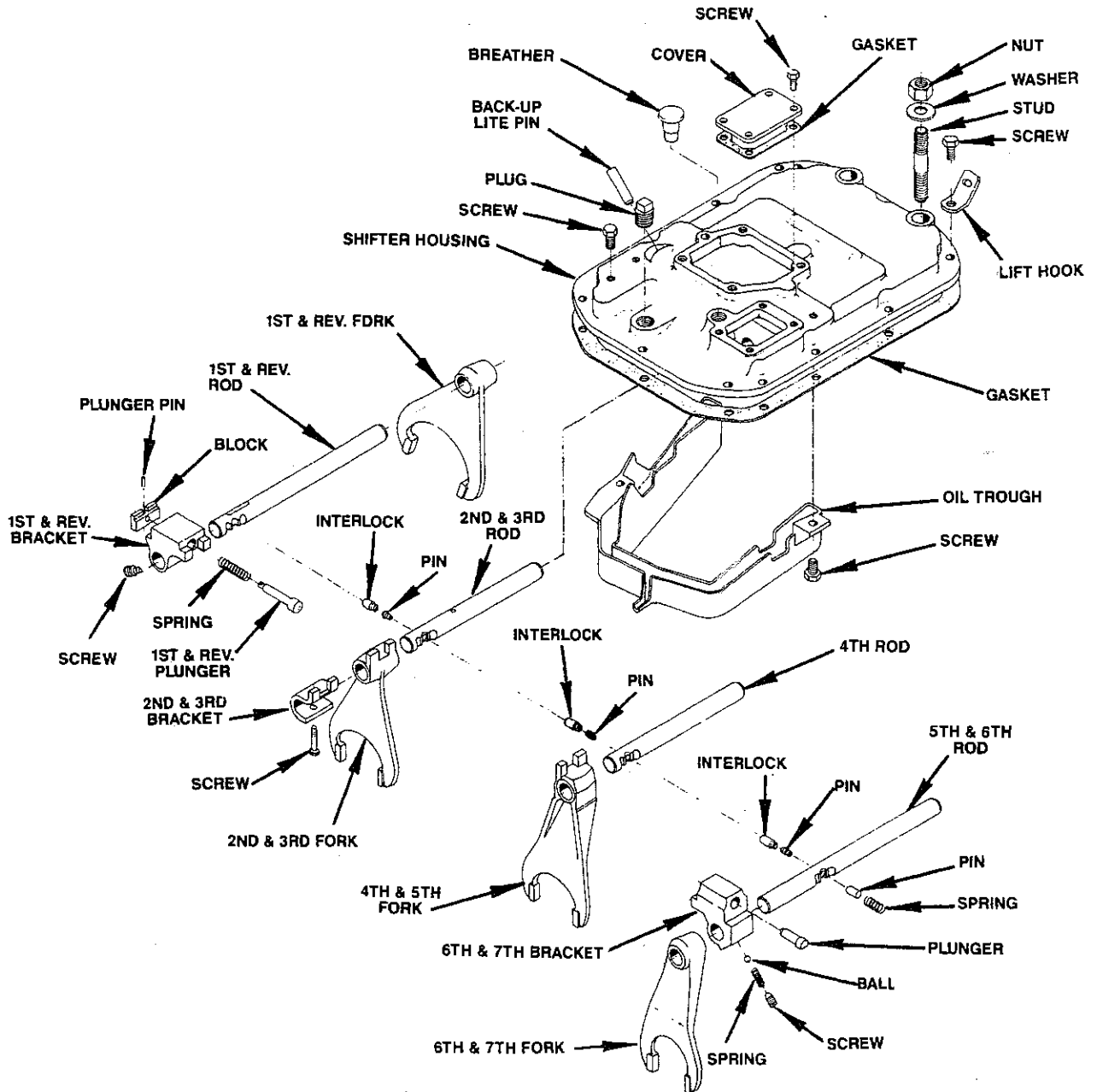

SHIFTER HOUSING DISASSEMBLY

SECTION IV-A

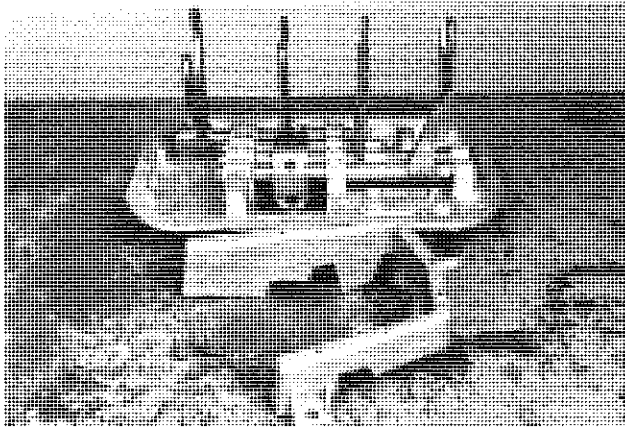

1. Place the cover on the bench with the forks in the neutral position, and remove oil trough.

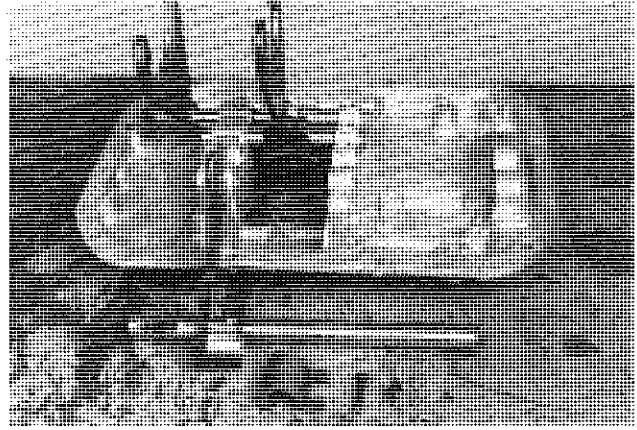

4. Remove 4th-5th fork and bracket screws. As the shift rod is pulled from cover, be sure not to lose the interlock pin and poppet.

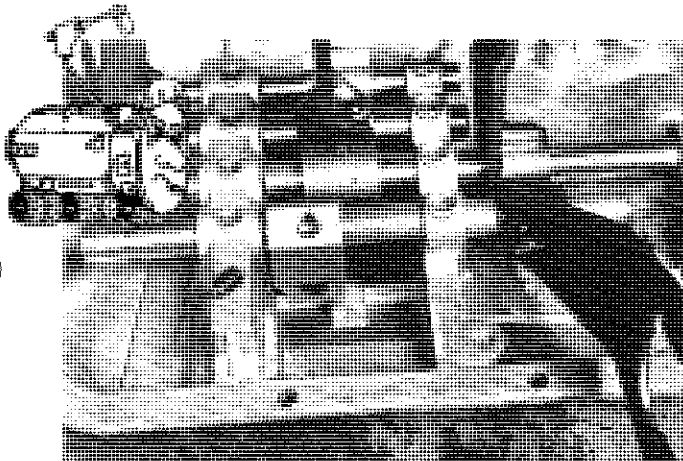

2. Remove 6th-7th bracket set screw. Now rotate fork and rod approximately 90 degrees. Note: The location of the interlock pin which must remain in a vertical position while removing rod to prevent damage to shift bracket spring.

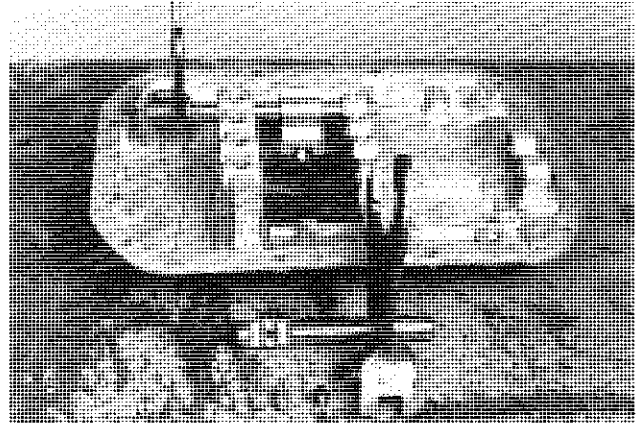

5. In the same manner, remove 2nd-3rd fork set screw, fork and rod from cover.

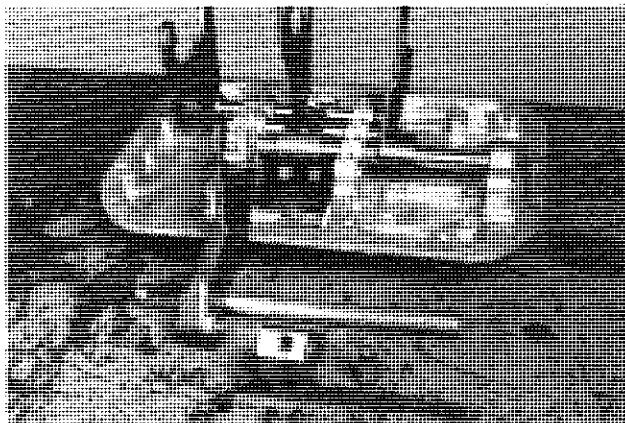

3. Continue disassembly by removing 6th-7th fork set screw, and remove rod toward rear of cover. (Forward Control: Remove rod toward front of cover.) Recover interlock poppets and pin, also shift bracket plunger, spring, and ball.

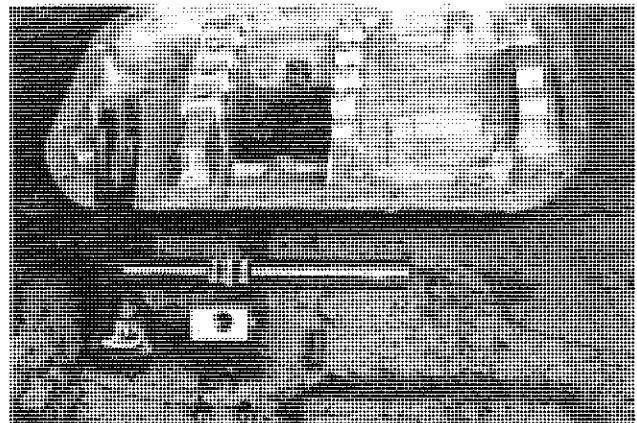

6. Next, remove 1st-Rev. fork and bracket to complete the disassembly of the shifter housing.

SHIFTER HOUSING DISASSEMBLY

SECTION IV-A

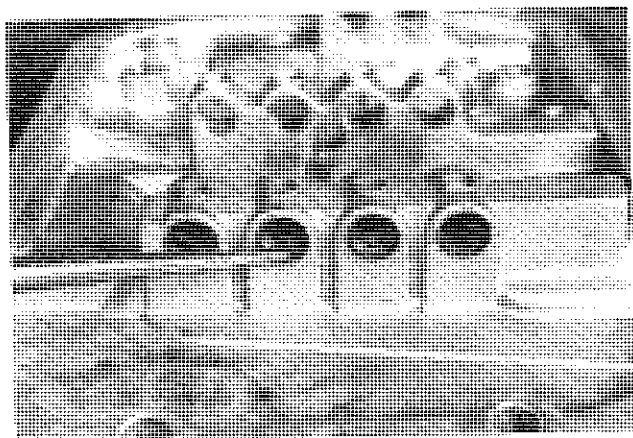

7. Check shifter housing for any signs of abnormal wear.

SHIFTER HOUSING DISASSEMBLY

SECTION IV-A

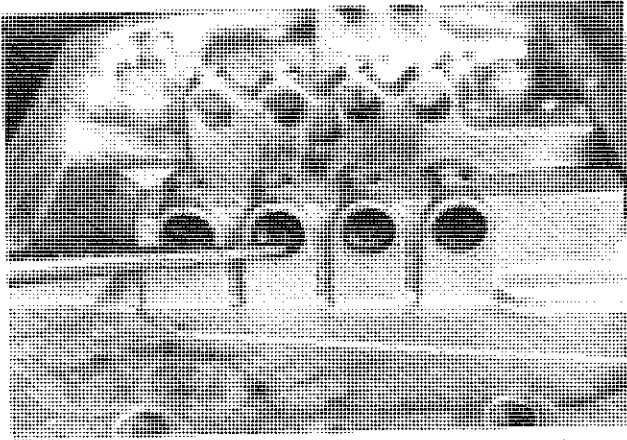

7. Check shifter housing for any signs of abnormal wear.

SHIFTER HOUSING REASSEMBLY

SECTION IV-B

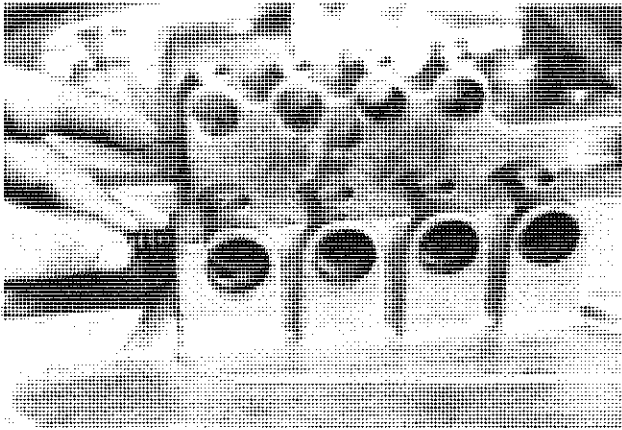

1. After inspection, the shifter housing is ready for reassembly. Insert interlock spring into cover.

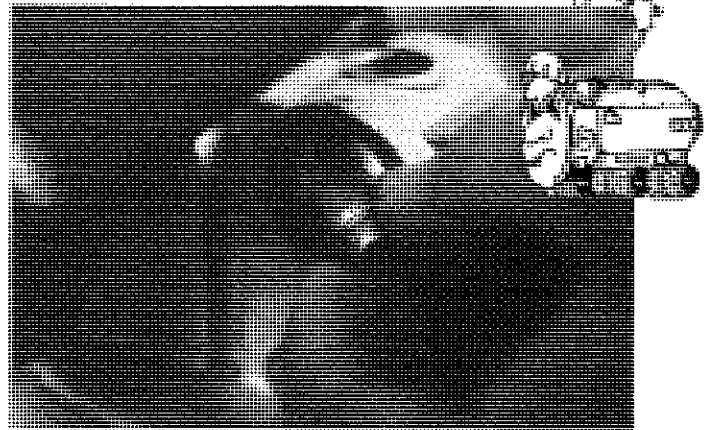

4. Install interlock poppet into cover. *Caution: During the installation of each rod, careful attention is needed to insure the proper installation of all interlocks. These interlocks prevent the transmission from being shifted into two gears at the same.*

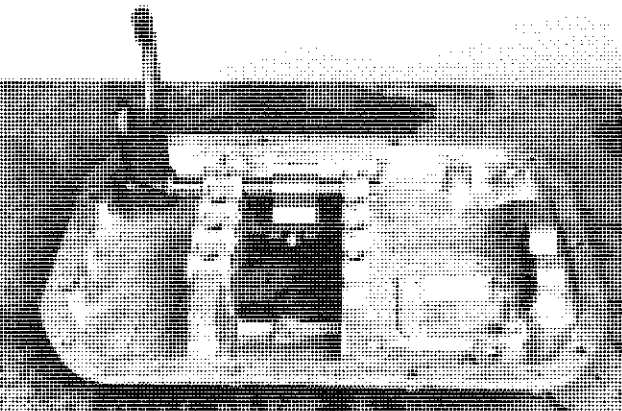

2. Install the 1st-2nd rod, shift bracket, and fork. Torque the set screws 26-32 pounds feet.

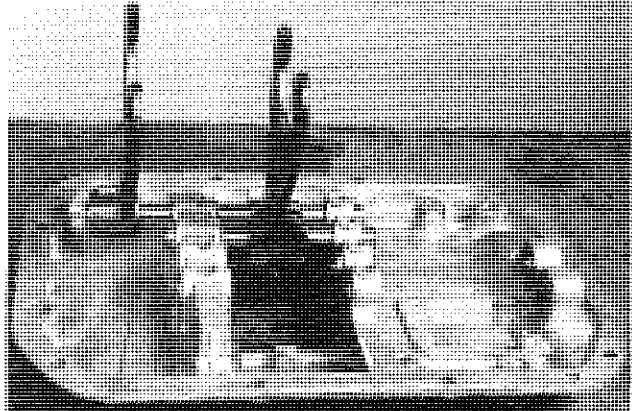

5. Install the 2nd-3rd shift fork and tighten set screw. Be sure to check each shift rod for free movement as the reassembly progresses.

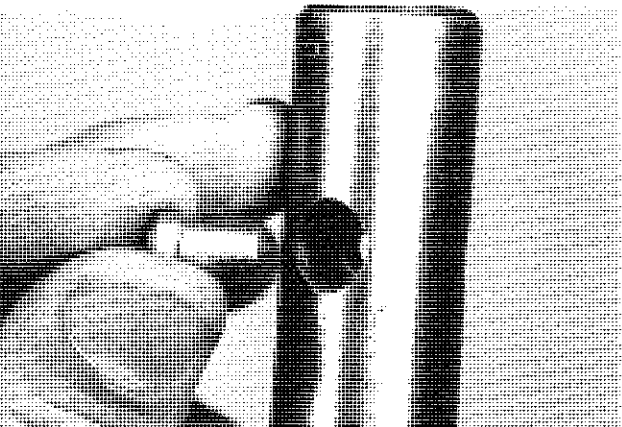

3. Insert interlock pin into 2nd-3rd shift rod.

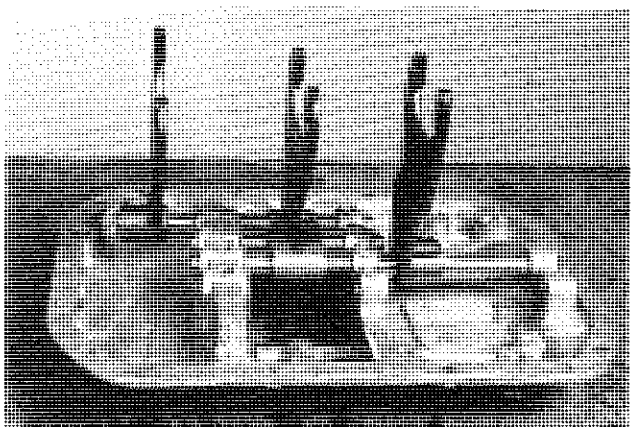

6. Install the 4th-5th shift rod, fork, and bracket. *Caution: Shift bracket bolt has fine threads, limit torque to 13-18 pounds feet.*

SHIFTER HOUSING REASSEMBLY

SECTION IV-B

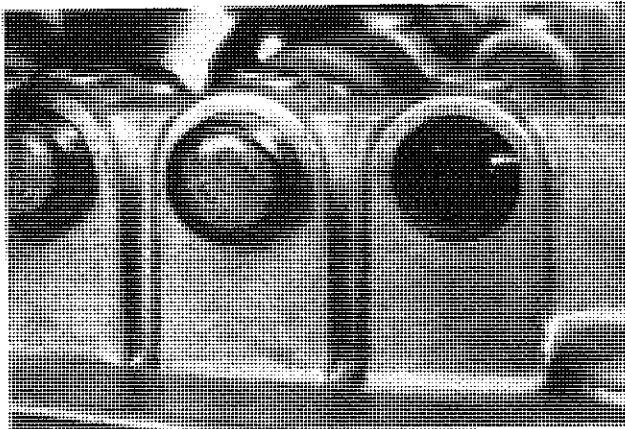

7. Install the last interlock pin and poppet. Next install the spring poppet.

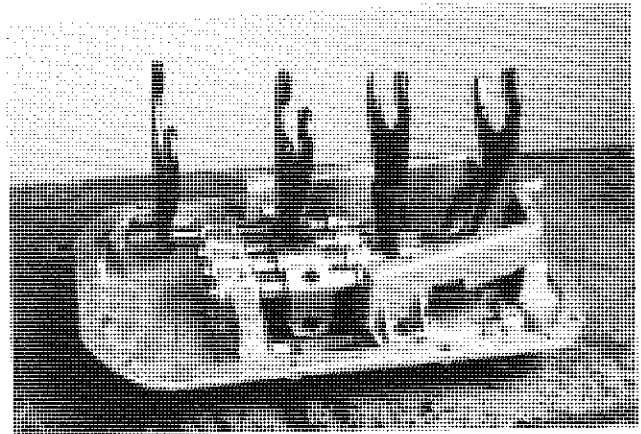

10. Install oil trough onto cover assembly. With the shifter housing reassembly completed, it is advisable to check for the proper functioning of these interlocks. Shift one fork into gear; if all interlocks are installed correctly, none of the other forks will shift into gear.

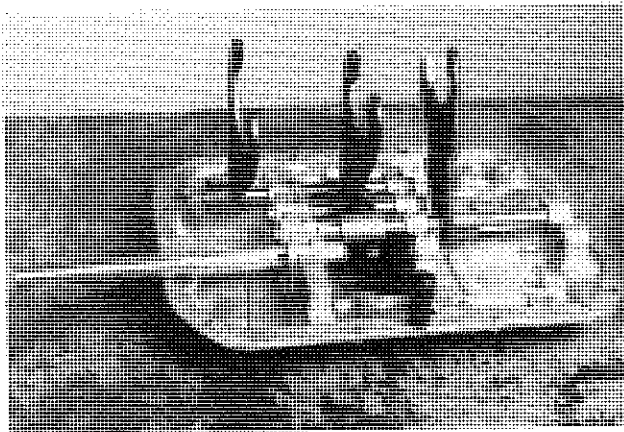

8. Compress spring poppet and insert rod with interlock hole facing upward. Positioning the rod in this manner will prevent damage to shift bracket plunger spring when installing rod.

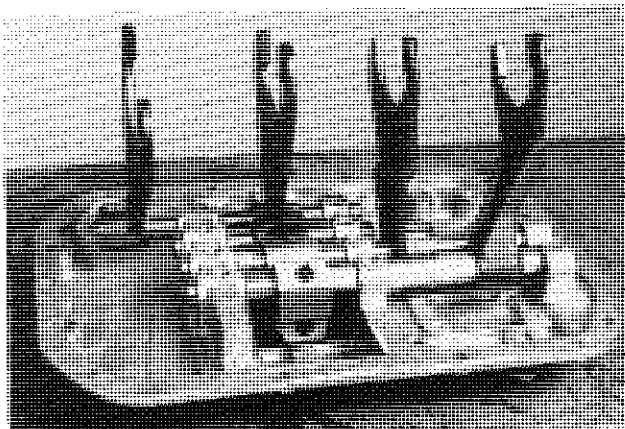

9. Insert plunger, ball, and spring into 6th-7th shift bracket. Compress spring and install shift bracket assembly to the rod. Add 6th-7th shift fork and tighten all set screws.

CASE SUB-ASSEMBLY

SECTION V

CASE SUB-ASSEMBLY
(Exploded view)

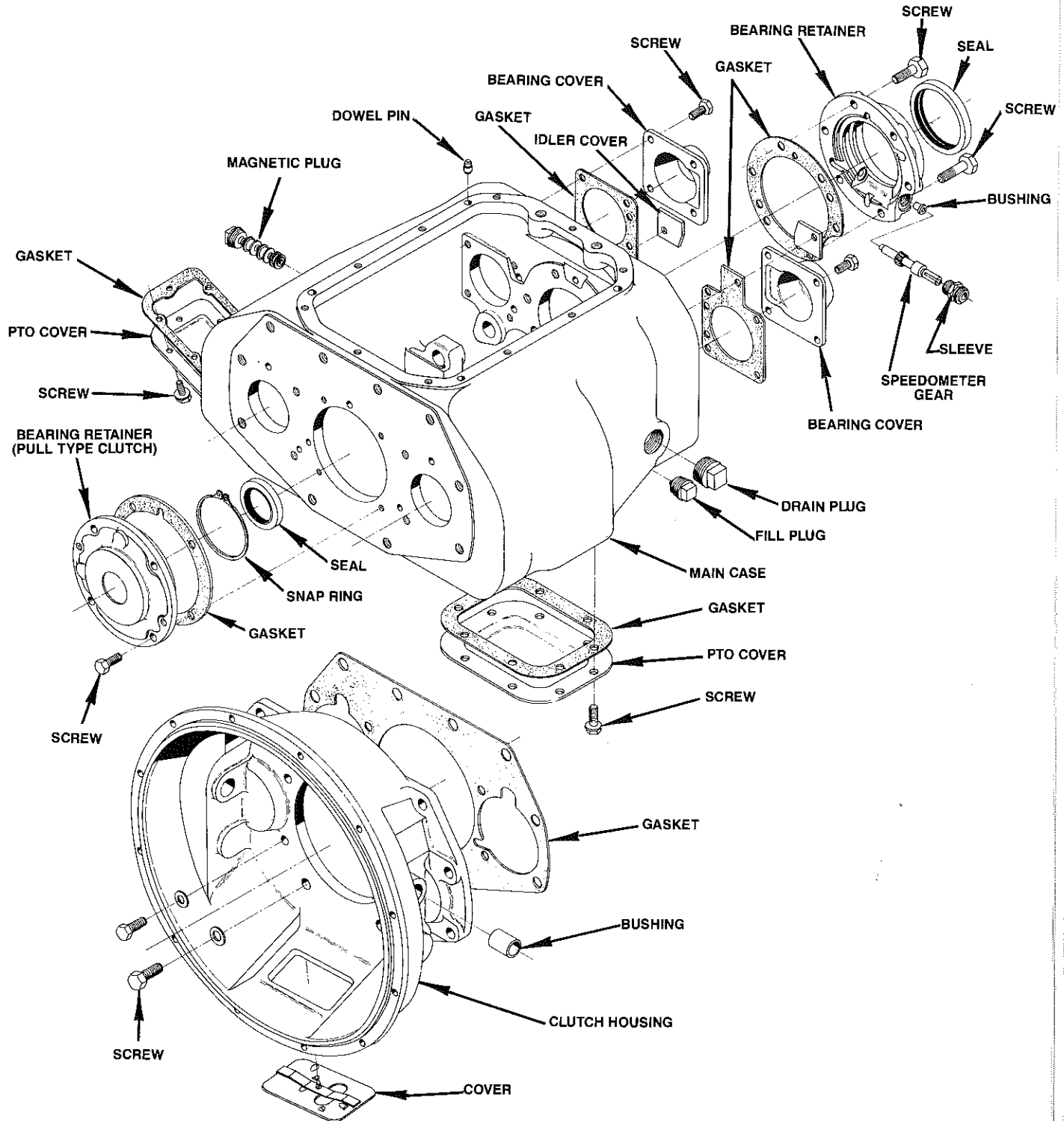

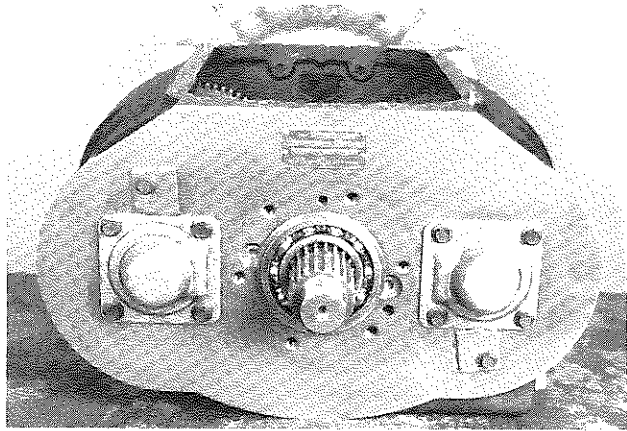

1. Now that the shifter housing is removed, continue the disassembly of the transmission by removing the output bearing cap and gasket.

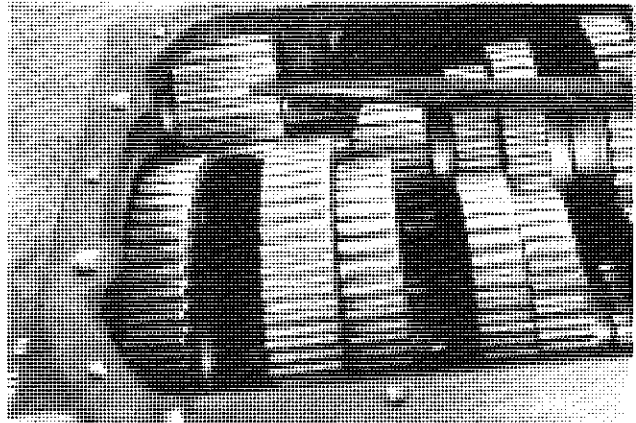

4. Roll the upper reverse idler gear toward the side of the case.

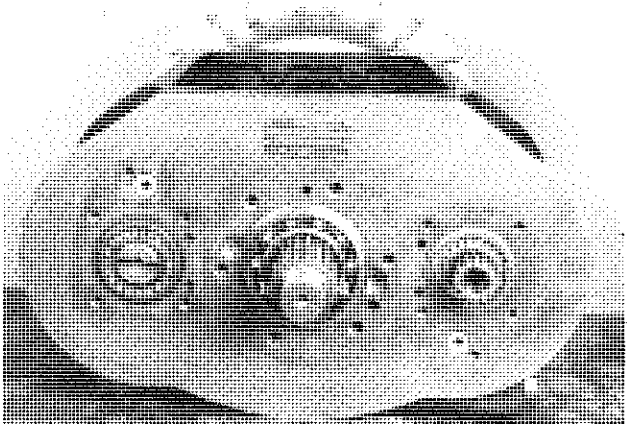

2. Remove the countershaft bearing retainers.

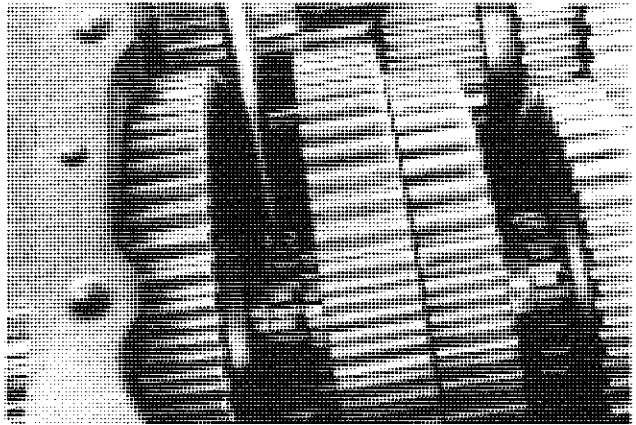

5. Engage the 1st-Reverse collar into reverse gear.

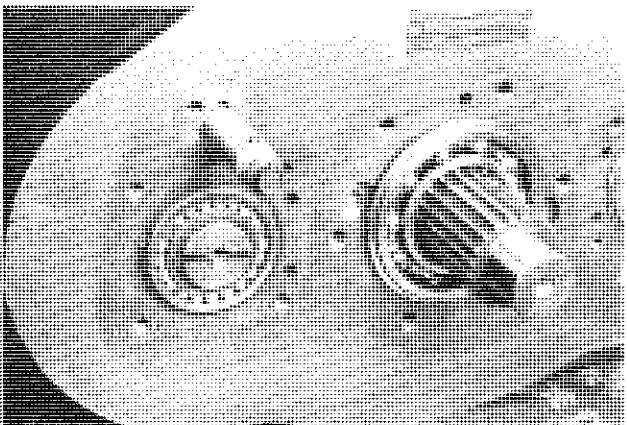

3. Insert a capscrew into the upper reverse idler shaft and remove the shaft. Do not lose the lockball in the shaft.

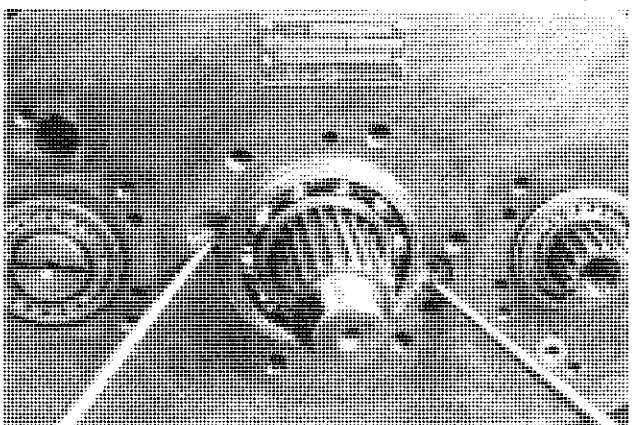

6. These milled slots facilitate the removal of this output bearing.

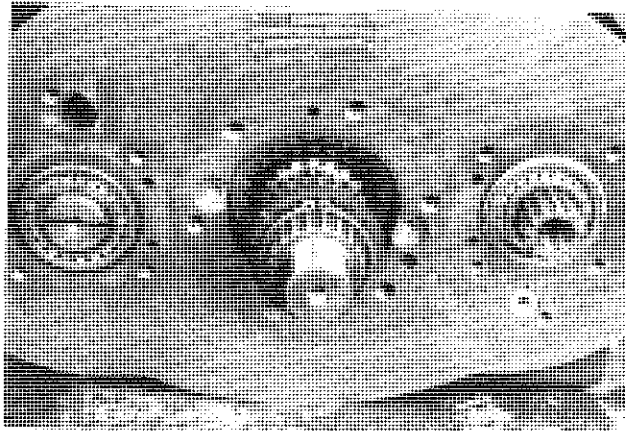

7. Remove the mainshaft snap ring and the internally splined thrust washer.

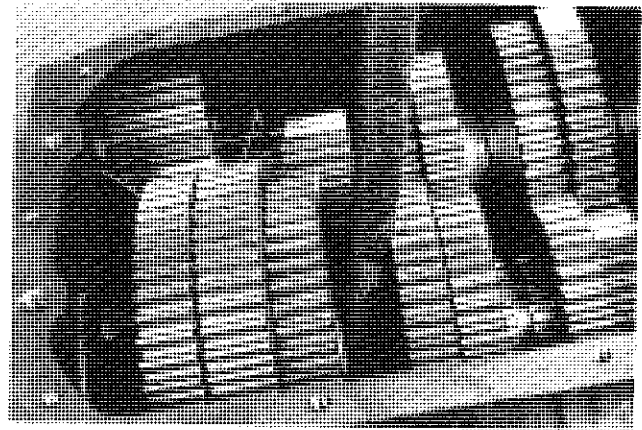

10. Now, butt the 1st and reverse gears together. Secure both gears with lockwire to provide the necessary clearance for removal of the mainshaft assembly.

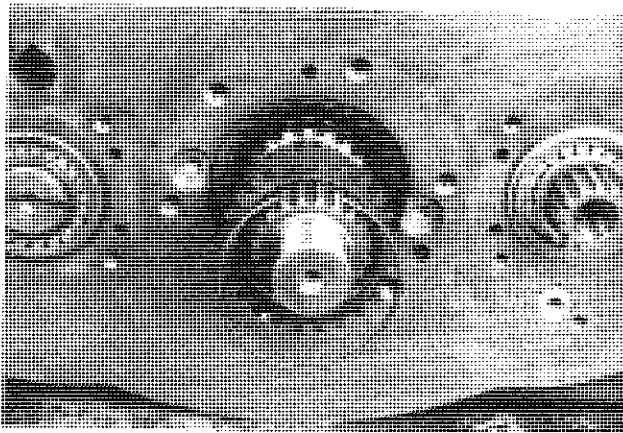

8. Next, remove the gear bore snap ring and both the externally and internally splined thrust washers.

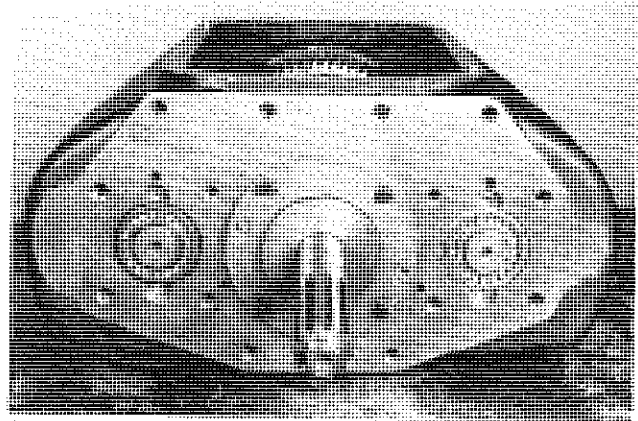

11. Remove the clutch housing.

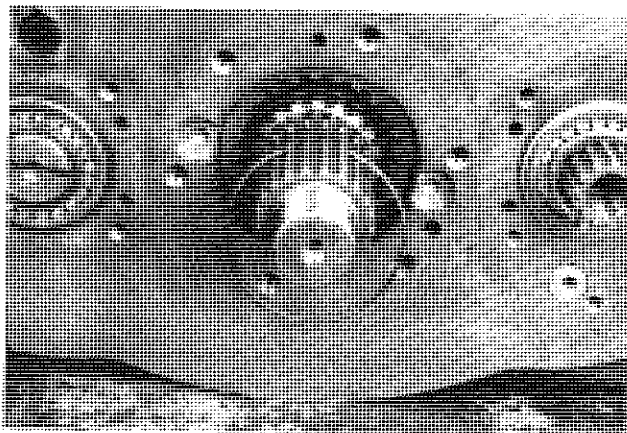

9. Finally, remove the remaining gear bore snap ring.

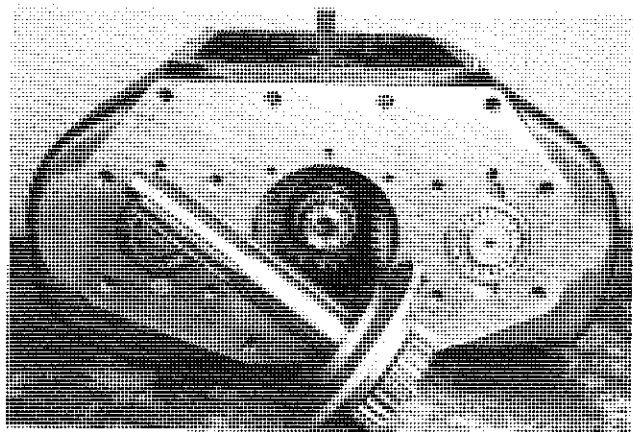

12. Remove the input shaft and bearing retainer assembly together.

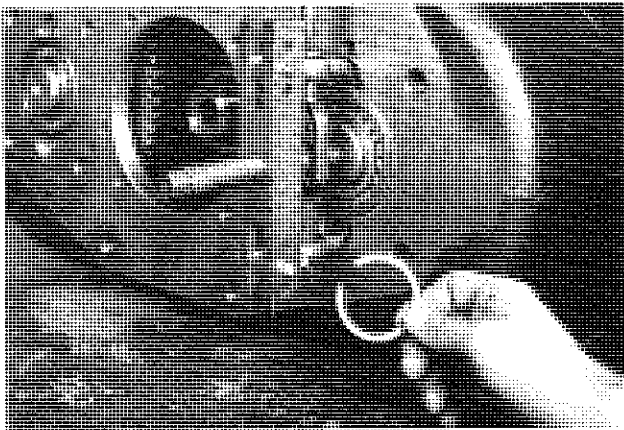

13. Using a puller, remove the countershaft front bearing.



16. Remove the upper reverse idler gear.

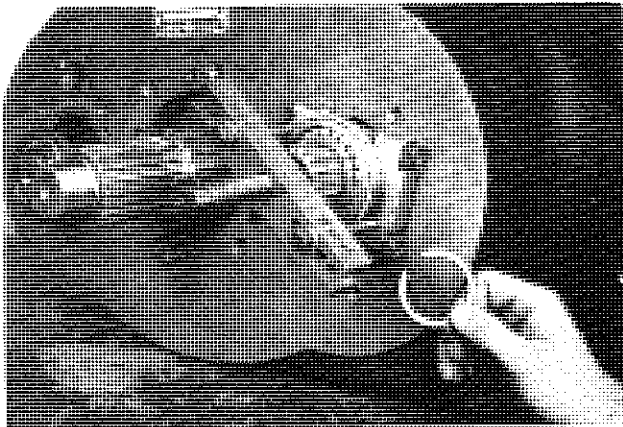

14. Now, move the countershafts to the rear as far as possible and install a puller for bearing removal.

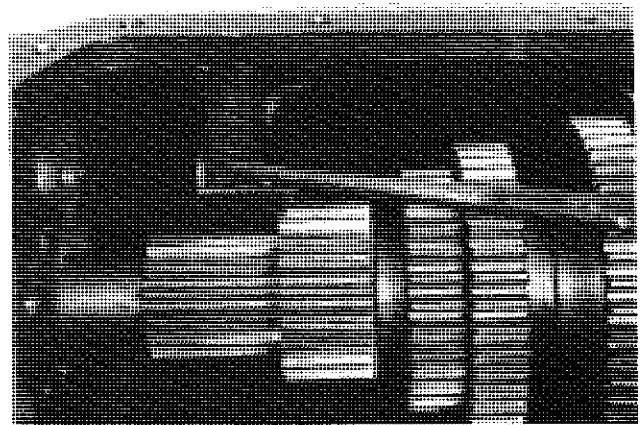

17. Because of this upper idler boss interference, remove the right side countershaft first.

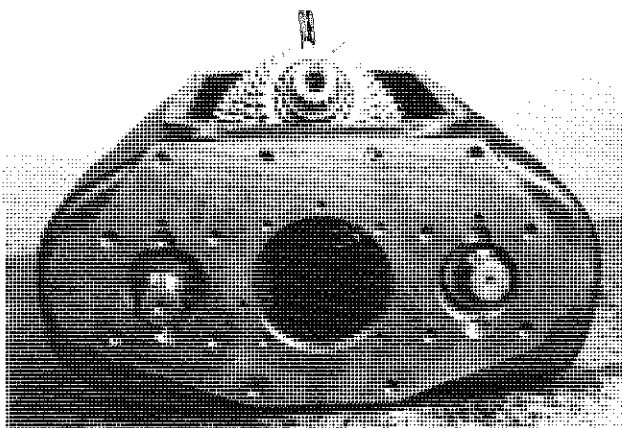

15. To provide adequate clearance for mainshaft removal, move both countershafts forward and toward the side of the case. Then lift the mainshaft assembly out of the case.

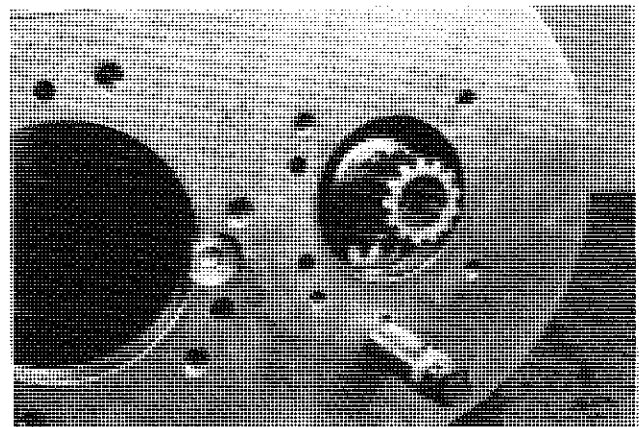

18. Remove both the lower reverse idler shaft and gear.

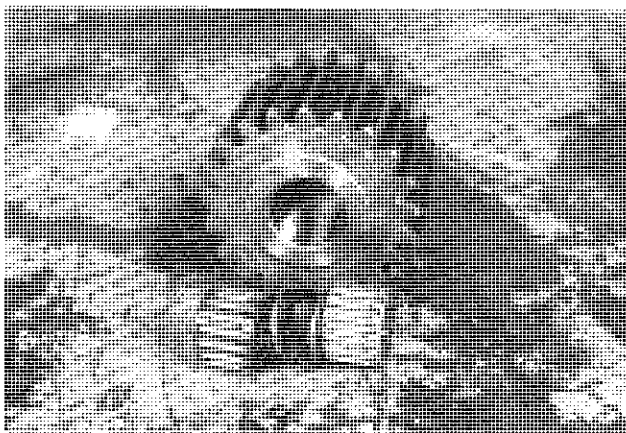

19. Check both the idler gear and bearings for wear.

GEARS & RELATED PARTS MAINSHAFT (Exploded views)

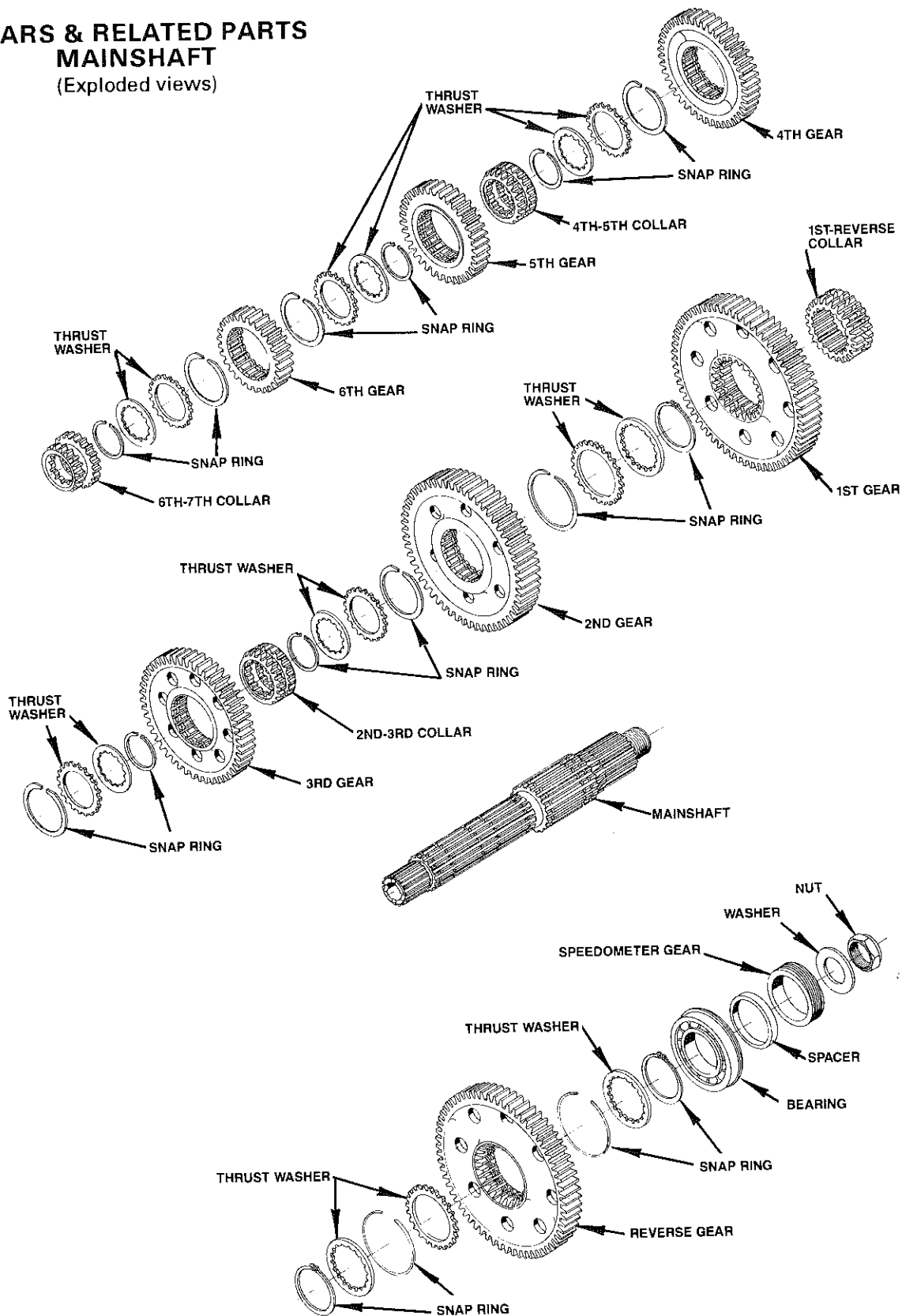

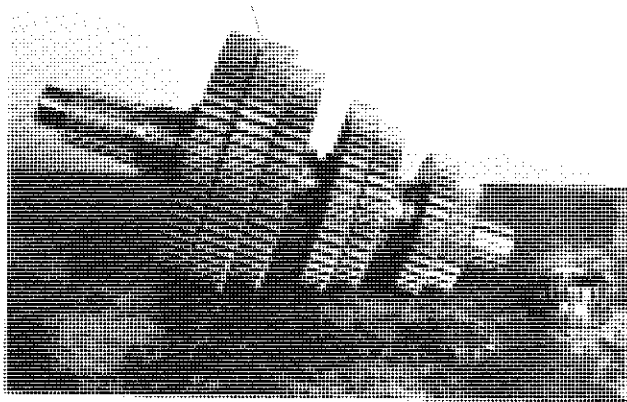

1. Begin the mainshaft disassembly by removing the clutch collar.

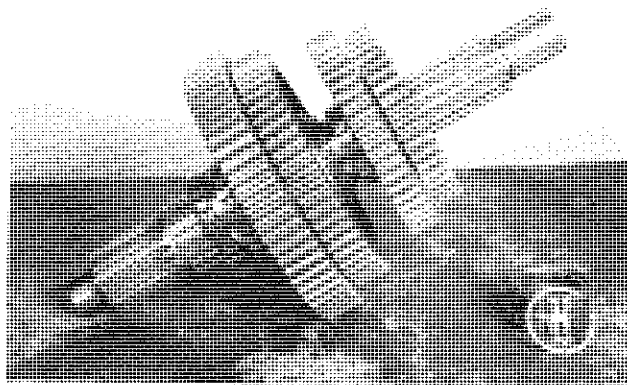

4. Remove another snap ring and the 5th-4th speed clutch collar.

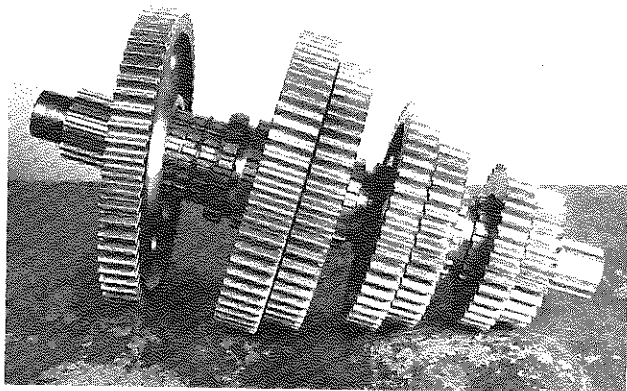

2. Cut the lockwire and remove reverse gear.

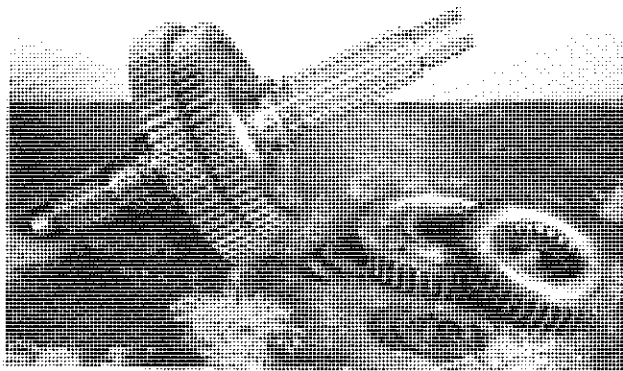

5. After removing the next snap ring, lift both the 4th and the 3rd speed gears from the mainshaft.

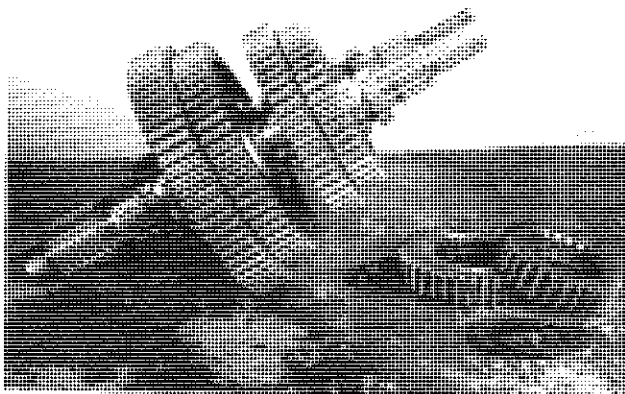

3. Remove the snap ring and 5th & 6th speed gear.

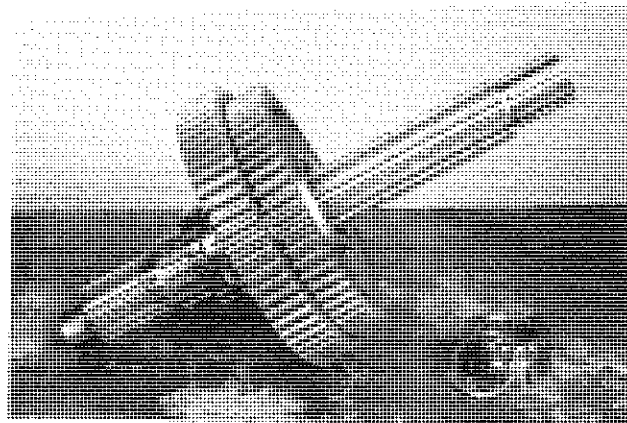

6. Remove another snap ring, then 2nd-3rd speed clutch collar may be removed.

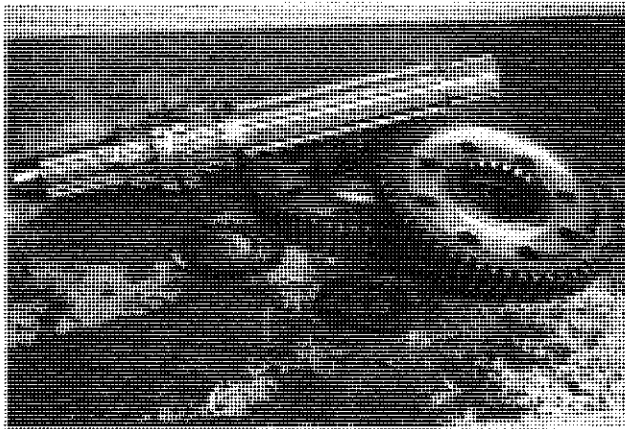

7. Another snap ring secures both the 2nd speed and the 1st speed gears.

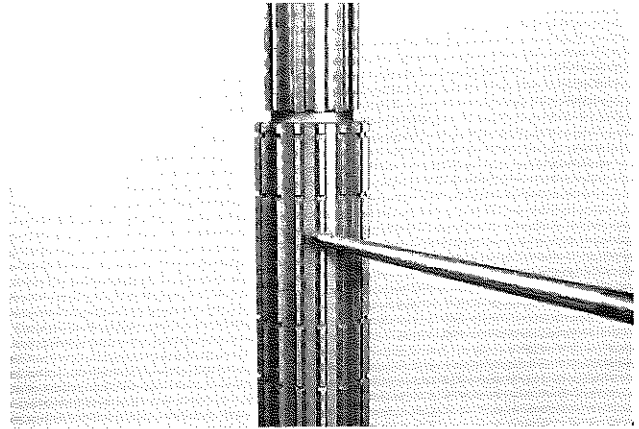

10. Spicer utilizes "gear locks" to maintain clutch collar engagement. The mainshaft splines have machined grooves.

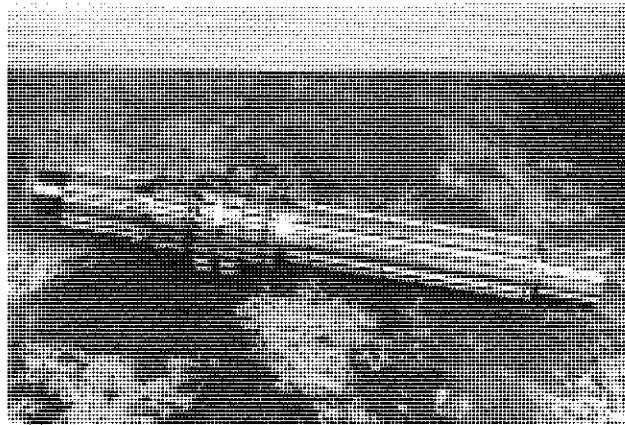

8. All that remains on the mainshaft are two snap rings and the 1st-Reverse clutch collar.

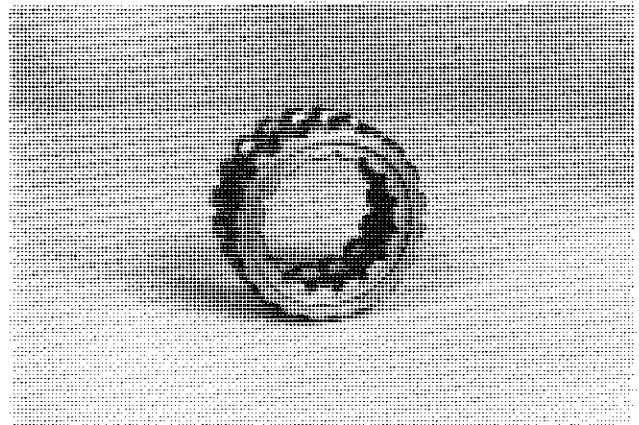

11. While the clutch collar has a relieved area on the internal diameter that provides sharp corners, when "in gear", these edges lock together to keep the transmission in the selected gear.

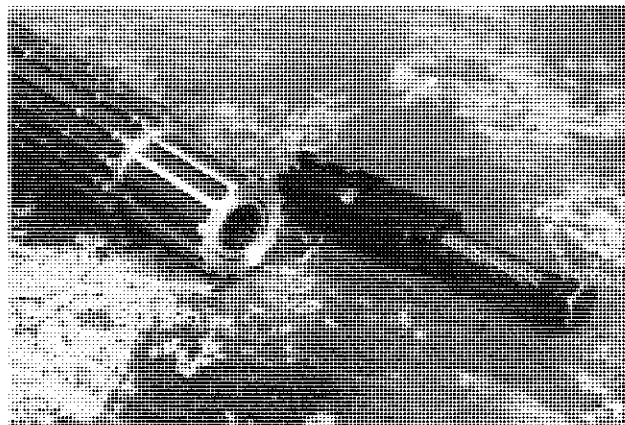

9. Remove the pocket bearing with an adequate puller.

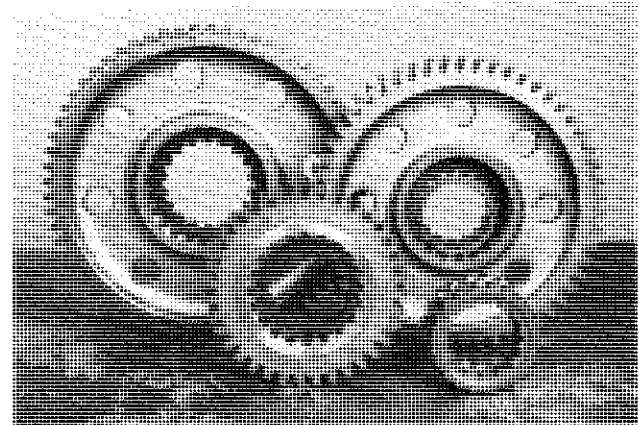

12. Reassembly of the mainshaft may now begin. Apply a light coat of oil or light grease on all thrust washer faces. All mainshaft gears contain a set of these thrust washers. The externally splined washer is positioned against the gear bore snap ring on the mainshaft.

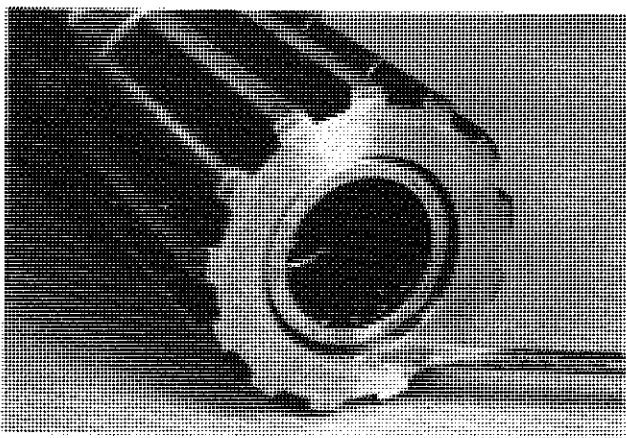

13. Install the pocket bearing to a depth of .070 inches.

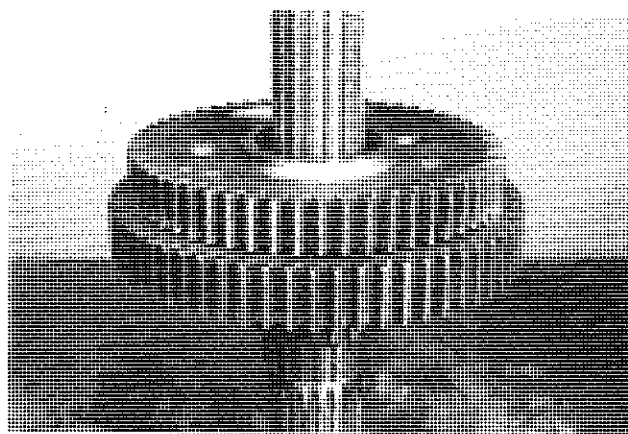

16. Place the 2nd speed gear on the mainshaft and secure with a mainshaft snap ring.

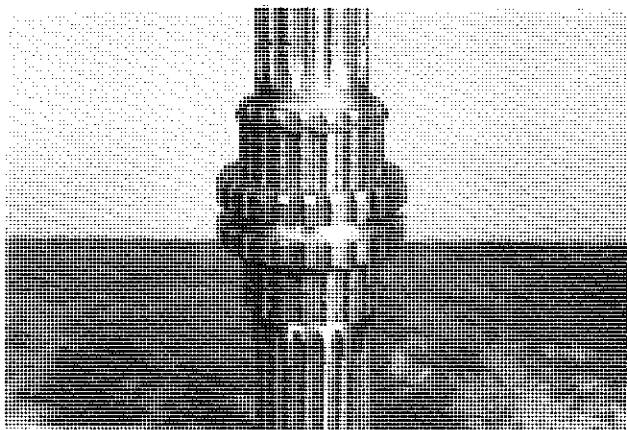

14. Install the 1st-Reverse clutch collar between the mainshaft snap rings.

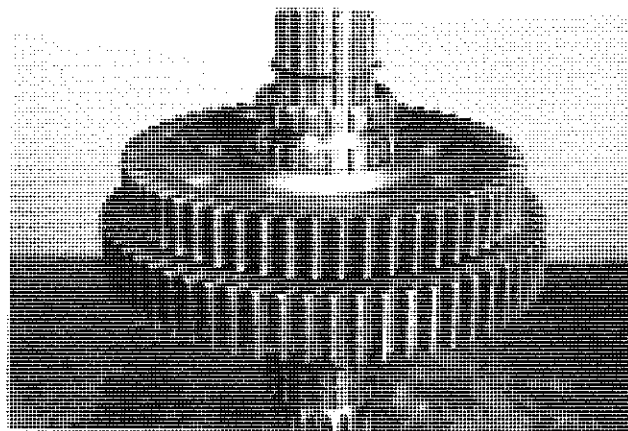

17. Slide the 2nd-3rd clutch collar onto the mainshaft and secure with a snap ring.

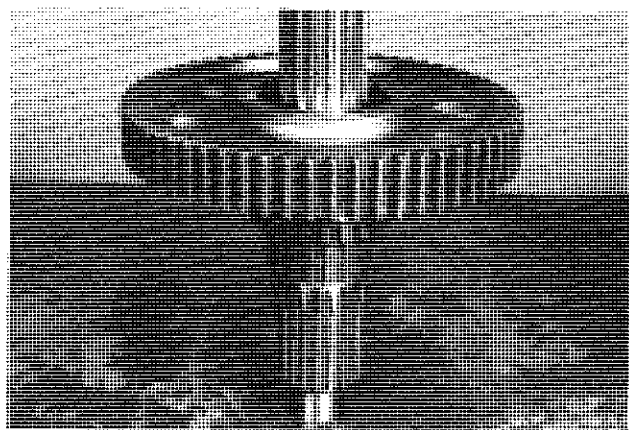

15. Next, the 1st speed gear, complete with thrust washers, is placed on the mainshaft.

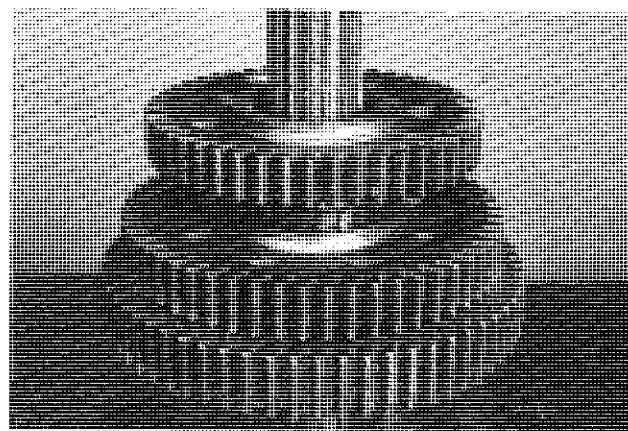

18. Place the 3rd speed gear on the mainshaft with the clutch teeth down.

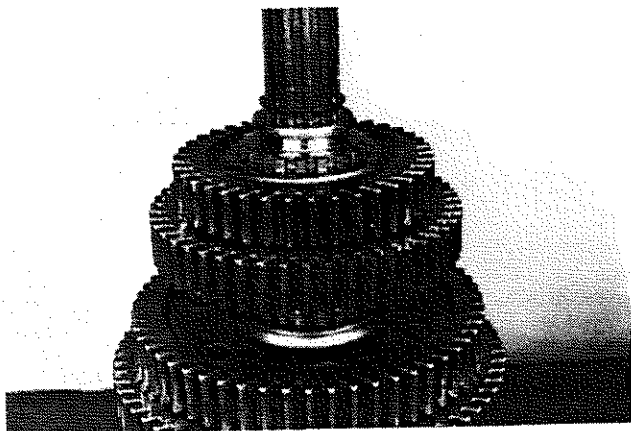

19. Slide the 4th gear clutch collar onto the mainshaft.

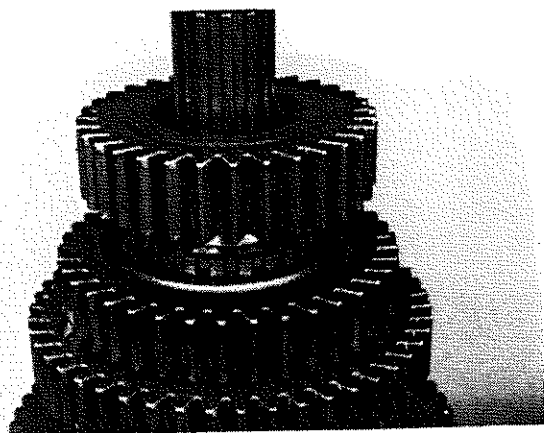

20. Then place the 5th speed gear on the mainshaft and secure with a snap ring.

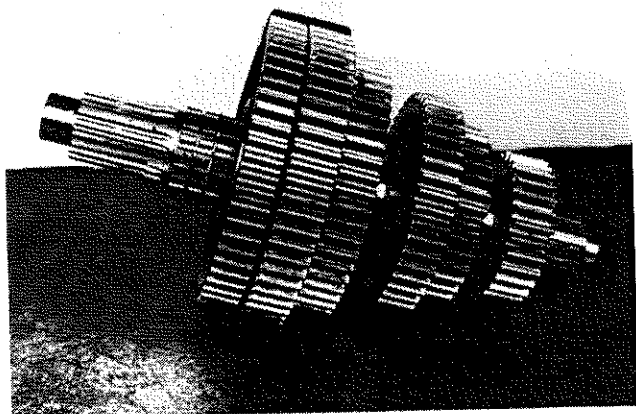

21. Install the reverse gear and butt it against the 1st speed gear. Secure with lockwire.

Inspection

Prior to reassembling the mainshaft, certain individual parts should be examined. Parts damaged from previous service should be eliminated to insure maximum rebuild life.

These suggested inspection procedures should be followed:

Clutch Collars: Both the internal and external teeth must have sharp edges. Rounded corners or excessive chipping will cause gear jumping. Also, examine fork slots for wear.

Gears: Examine for broken or cracked operating teeth. Also, check for any unusual wear patterns. Clutching teeth must not show excessive wear.

Thrust Washers: Check for flatness or excessive face wear (cracks, scoring, etc.)

Snap Rings: Examine for distortion or loss of tension. New snap rings are recommended with every rebuild.

Mainshaft: Check spline gearlocks for sharp corners. Worn or ironed out gearlocks will produce gear jumping. Also, check for chipped splines at snap ring grooves.

TORQUE SPECIFICATIONS FOR NUTS AND CAPSCREWS

NOM. THREAD SIZE (DIA.)	PART NAME	WRENCH TORQUE FT. LBS.			
		NON-LOCKING TYPE		LOCKING TYPE (Bonded Nylon Patch)	
		MIN.	MAX.	MIN.	MAX.
.250 6	Cap Screw or Nut	7	10	10	13
.312	"	13	17	20	24
.375 10	"	25	32	34	41
.438	"	40	50	52	62
	"			60	80
.500	"	60	80	78	98
	"			80	100
.562	"	90	115	112	137
.625	"	120	150	150	180
.750	"	200	250	240	290
1.250	Nut			400	450
1.375	"			550	600
1.750	"			550	600
	PTO Aperature Cover Capscrews				
.375	Capscrew	10	15	16	24
.438	Capscrew w/Gasket 97-324-2	20	25	36	41
.438	Capscrew w/Gasket 22p22	20	25	29	34
	Shift Fork Or Bracket Set Screws	Lockwire Type			
.375	Set Screw	25	32	34	41
.436	"	25	32	34	41
.438	"	40	50	52	62
	Idler Cover	Self Tapping			
10		25	32		

On all transmissions with .750-14 NPTF drain plugs, the drain plug torque should be 50-65 ft. lbs. The only exceptions are the ES42-5, ES52-5, CM40, CM49 and CM55 Models. The torque on these units should be 30-45 ft. lbs.

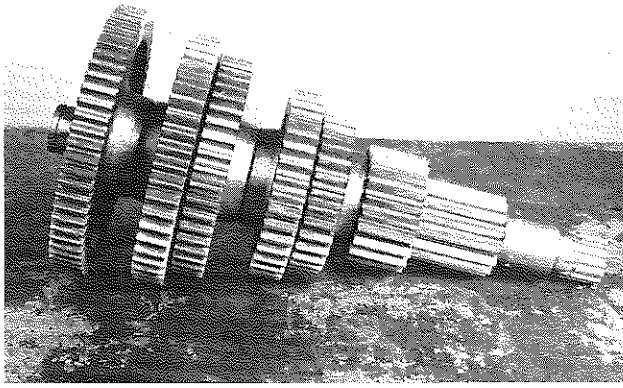

1. This view shows the hub direction of the gears. The 1st-Reverse gear is an integral part of the shaft, while the remaining gears are secured with individual Woodruff keys under each gear.

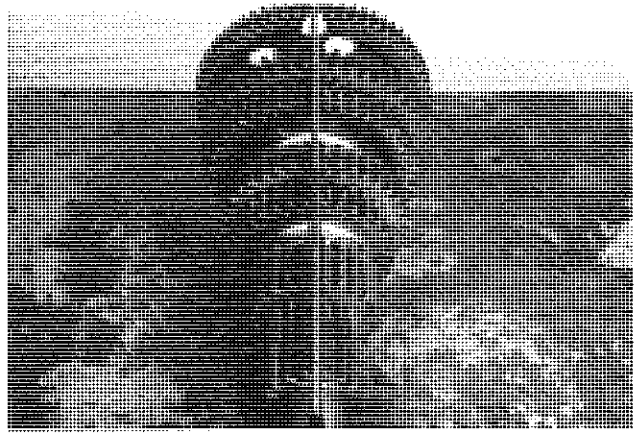

2. If you place a straight edge between these painted teeth, every gear on the countershaft will be in line. When you set these shafts in time, these marks will be directly across from each other.

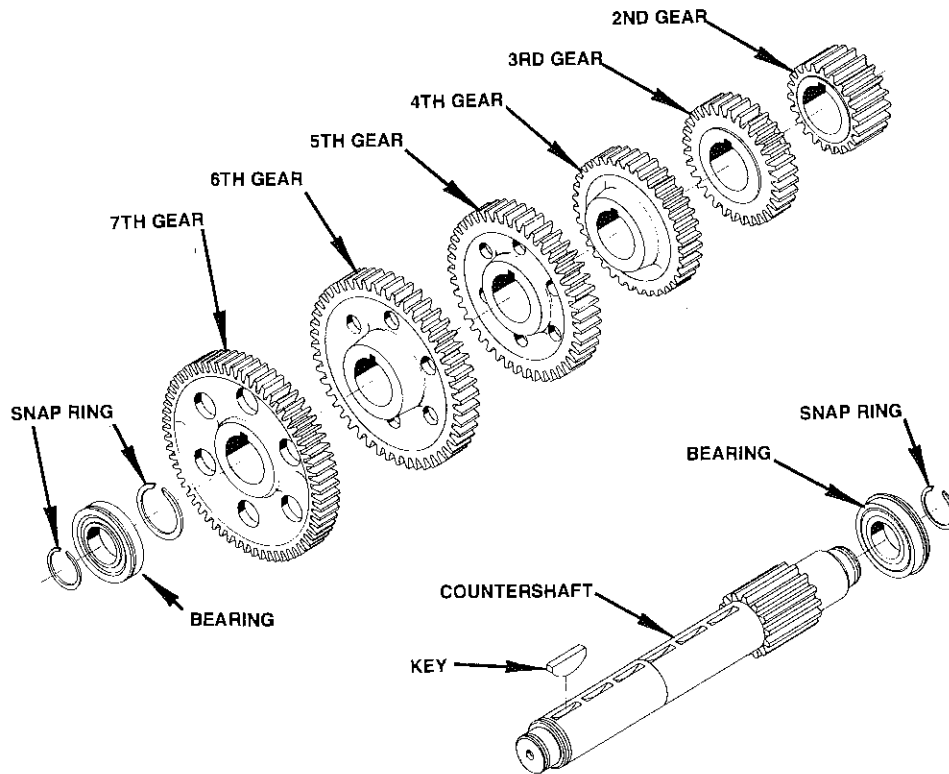

INPUT GEAR DISASSEMBLY & REASSEMBLY SECTION VIII

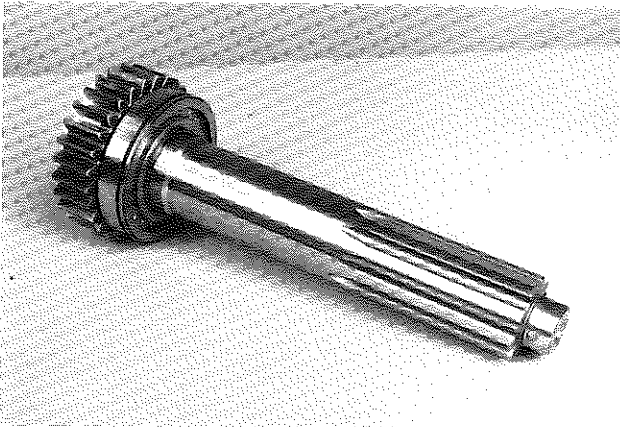

1. The input gear, shaft, and bearing are separate components secured with a snap ring.

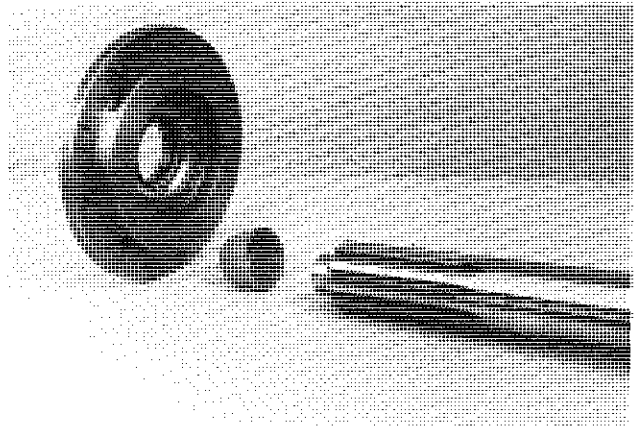

4. Then insert input shaft through bearing retainer. Use an installation sleeve to protect seal. Do not use grease on this seal. The shaft and seal must be oil free when mated to provide an effective seal.

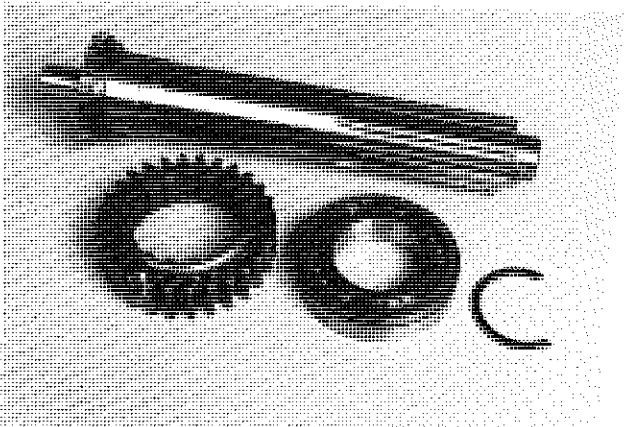

2. This view shows the input sub-assembly when disassembled.

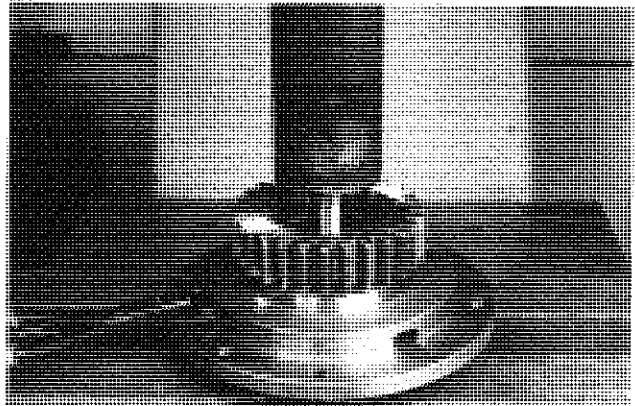

5. Expand snap ring through slot provided, while pressing input shaft assembly into the bearing retainer. Caution should be used during this procedure.

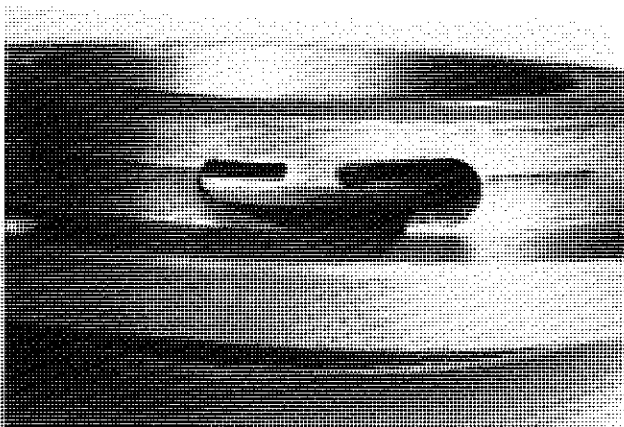

3. When reassembling, first install snap ring into input bearing cap.

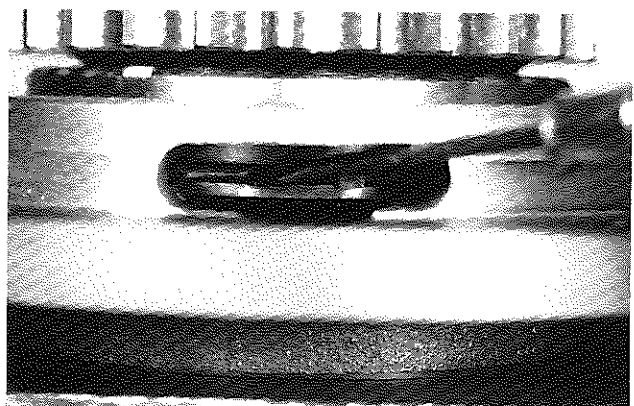

6. When snap ring grooves on the input shaft bearing and bearing retainer are in proper alignment, discontinue pressing and seat snap ring in place. Inspect assembly to assure the snap ring is properly seated and secured.

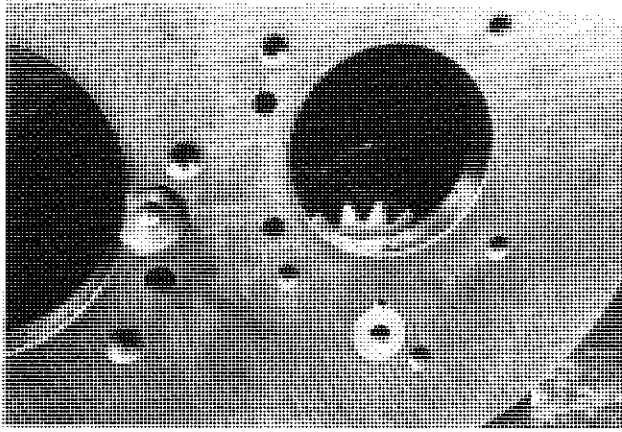

1. Reassembly of the transmission begins by placing the lower reverse idler gear and the shaft into the case.

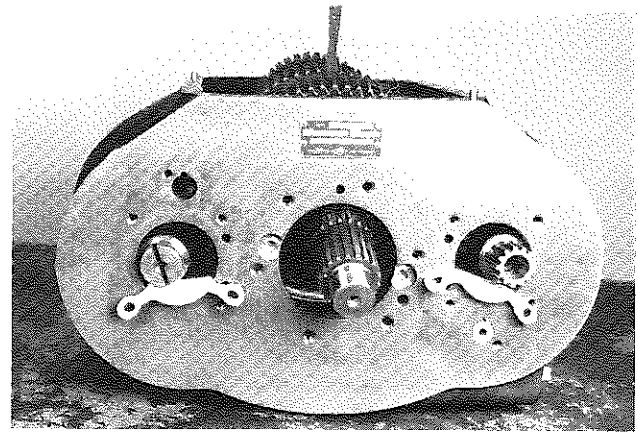

4. Lower the mainshaft assembly into the case.

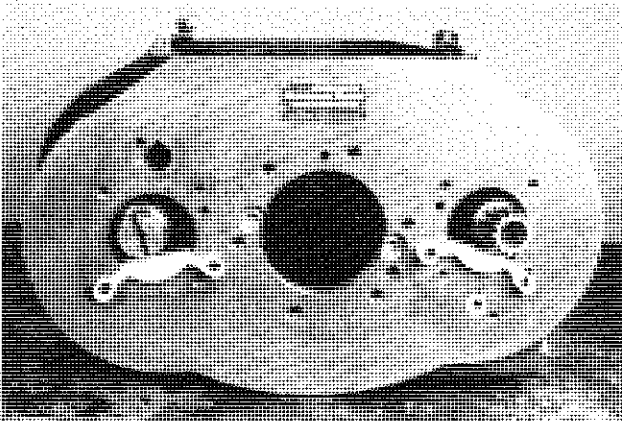

2. Install the left side countershaft first, then the right side. Kent Moore alignment blocks J-28720 are recommended.

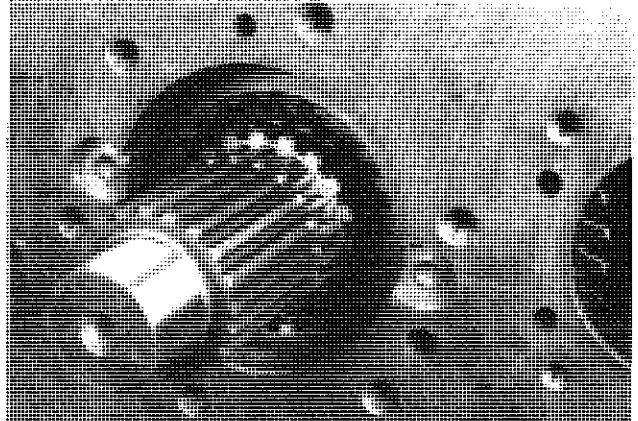

5. Cut and remove the lockwire. Slide the reverse gear rearward and install the first gear bore snap ring.

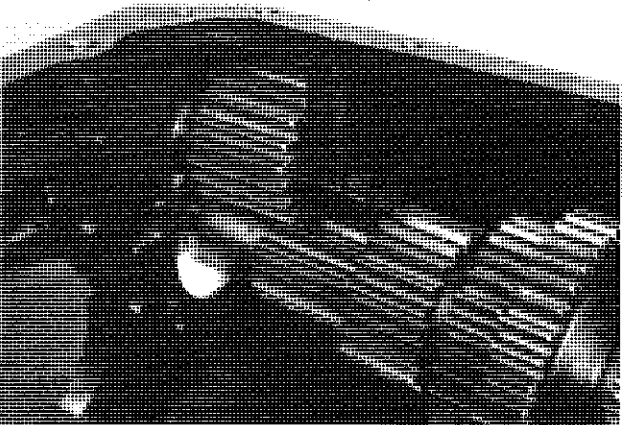

3. Set the upper reverse idler gear into the case. However, do not install the shaft at this time.

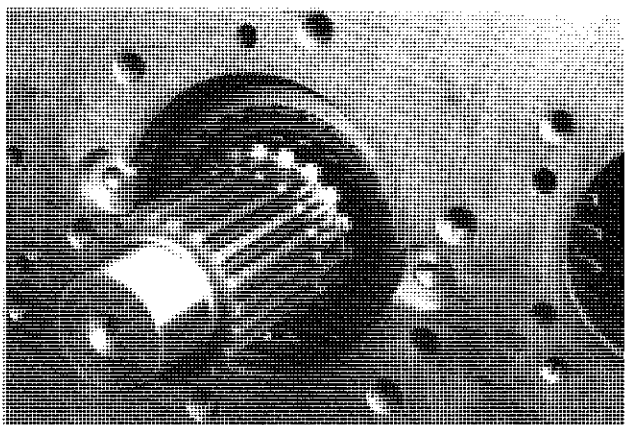

6. Next, place both the internally and the externally splined thrust washers into the bore and secure these washers with the remaining gear bore snap ring.

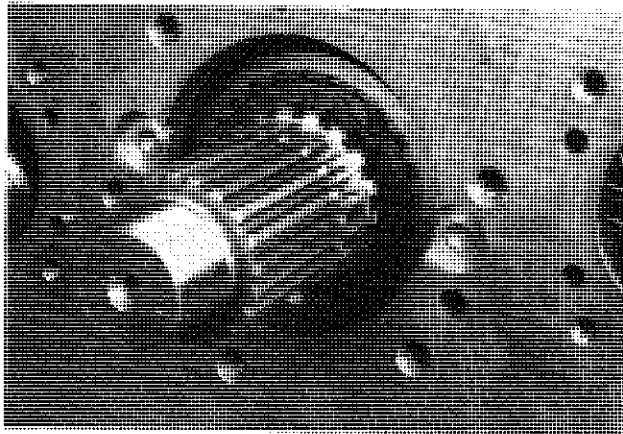

7. Finally, install the internally splined thrust washer and secure it with the mainshaft snap ring.

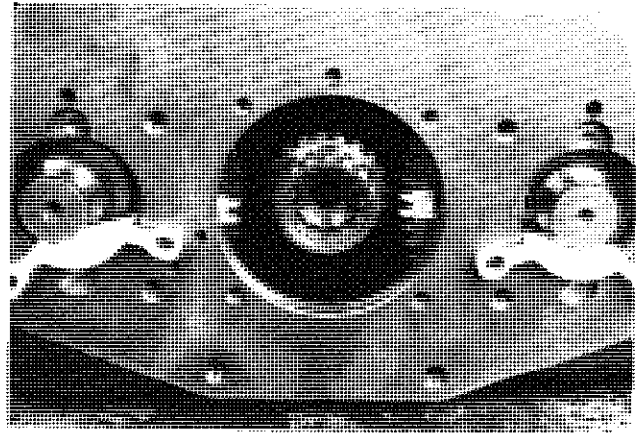

10. Install the 6th-7th clutch collar.

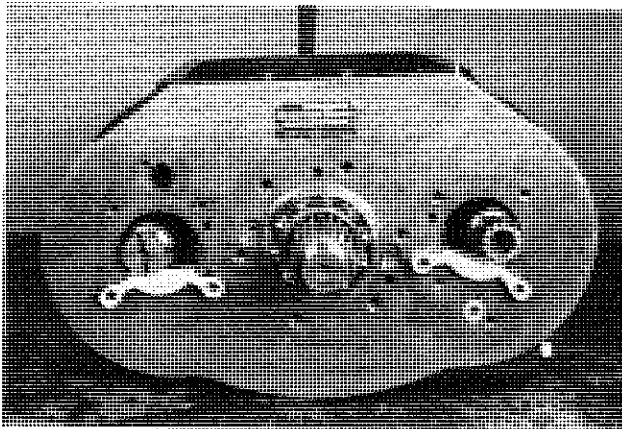

8. Slide the output bearing onto the shaft and using a suitable driver, install the bearing.

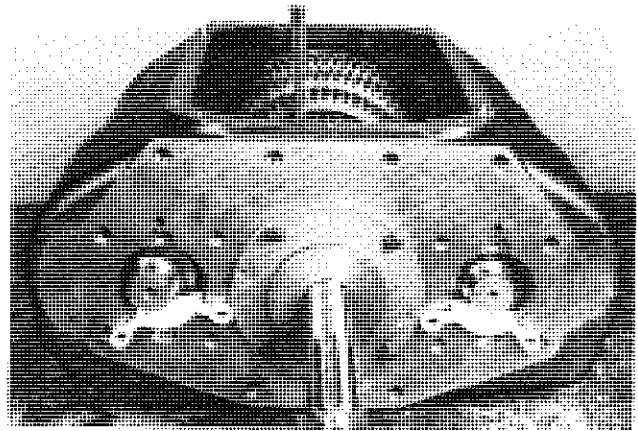

11. Insert the input and bearing retainer assembly into the case, and secure with capscrews.

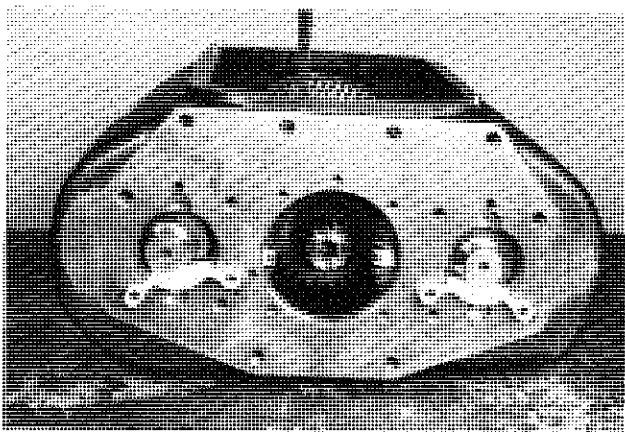

9. Align the countershaft timing marks toward the center of the case.

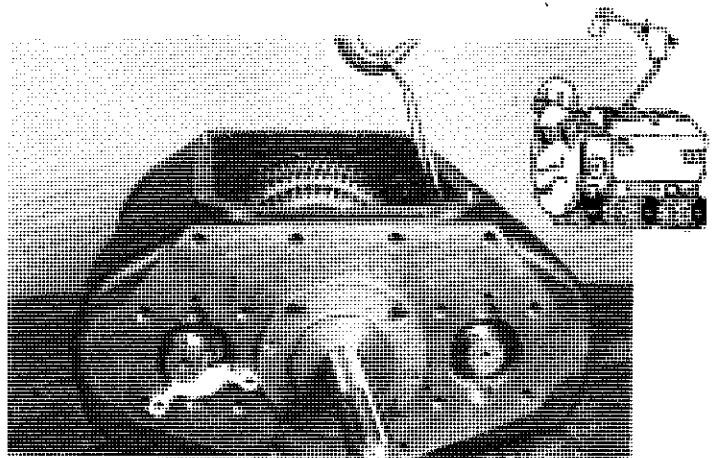

12. With the aid of a countershaft lift hook, Kent-Moore J-23667, set the right countershaft in time. Install front and rear countershaft bearings and secure with snap rings.

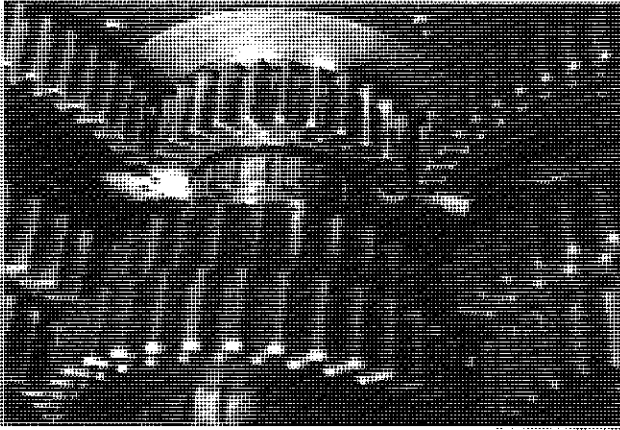

13. This is accomplished by matching paint marks.

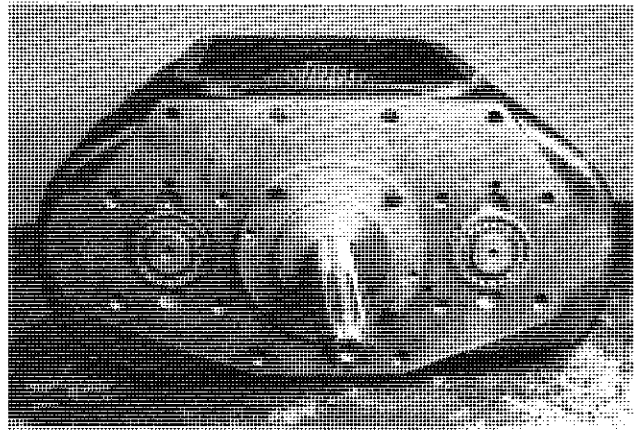

16. The input shaft may now be rotated to check for correct timing. If the shaft turns freely, the unit is in time. If it locks up, check the timing marks for proper alignment.

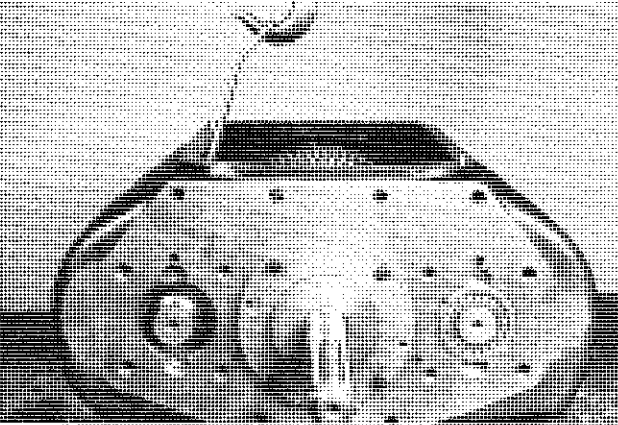

14. Repeat this procedure for the remaining countershaft.

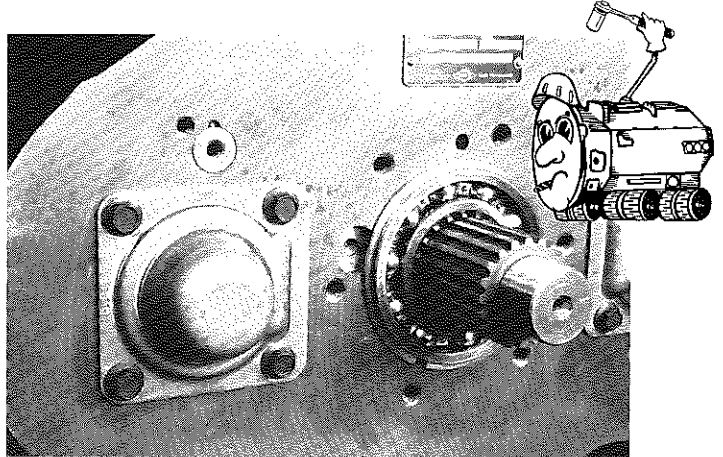

17. Install the upper reverse idler shaft with lockball. It is necessary to lift up on the mainshaft reverse gear to obtain proper alignment. Install and torque rear countershaft bearing caps and screws, 34-41 pounds feet.

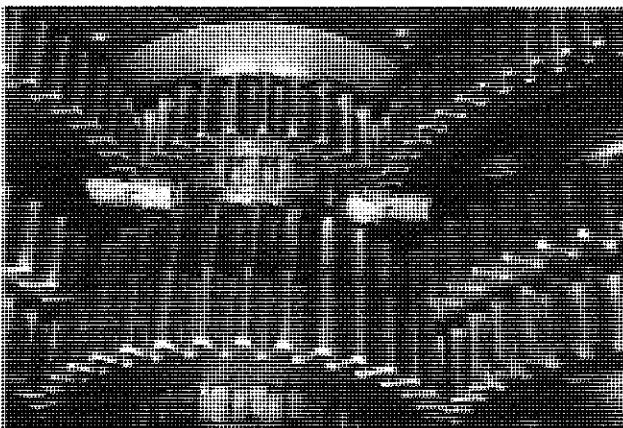

15. Check all timing marks to assure proper timing of gears.

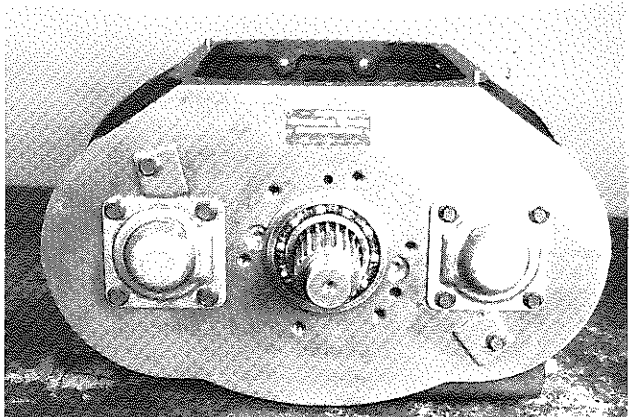

18. Secure the remaining idler shaft retainer cap screws and plates. Torque 34-41 pounds feet.

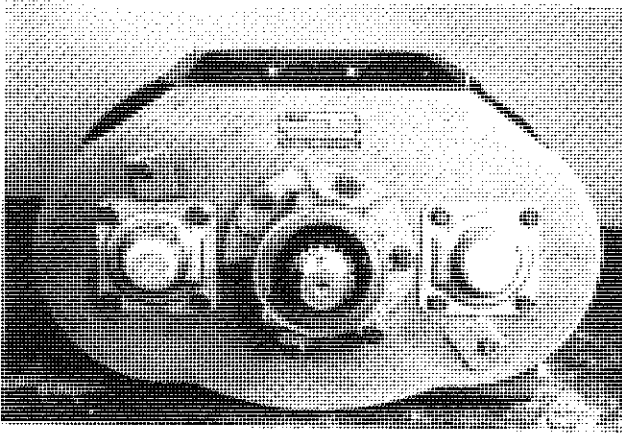

19. Place the output bearing cap and gasket on the case and secure with capscrews.

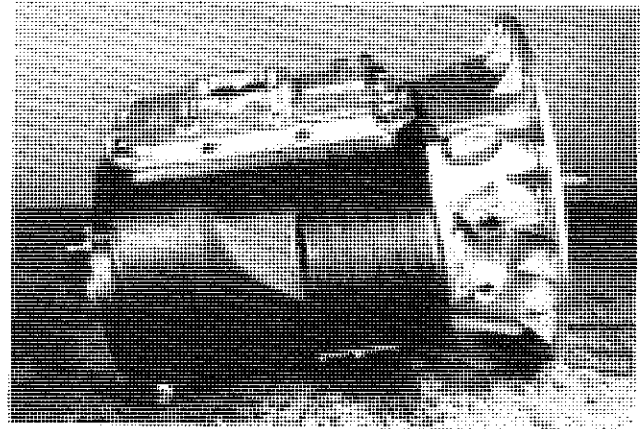

22. Place the shifter housing in its proper location and secure with capscrews. Torque 34-41 pounds feet.

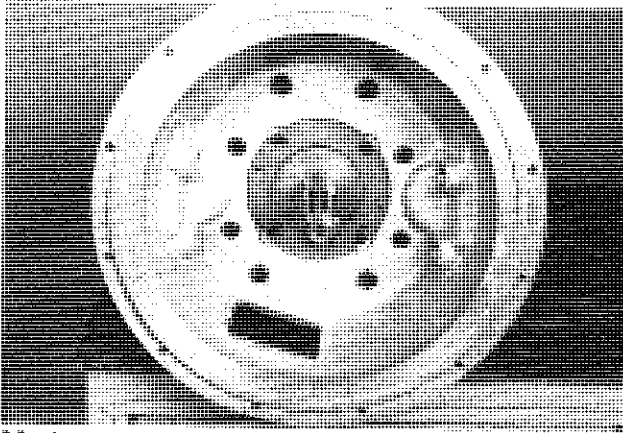

20. Assemble the clutch housing to the case.

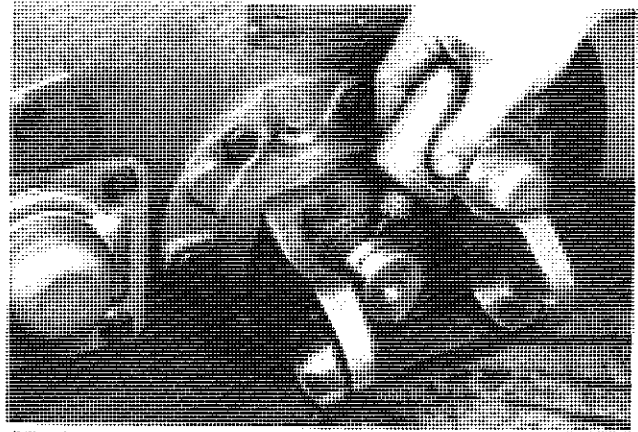

23. Add Locktite 242 adhesive.

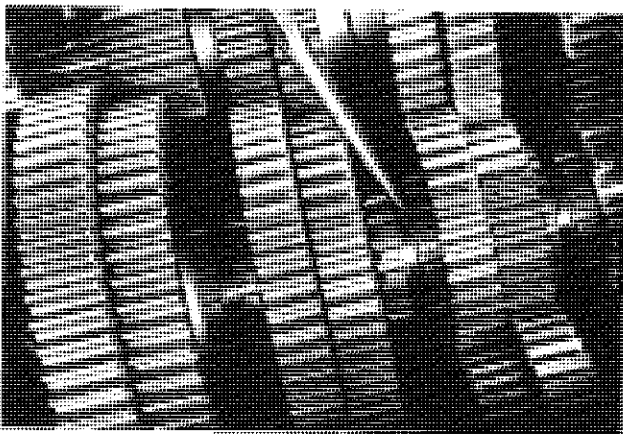

21. Shift all the clutch collars into the neutral position.

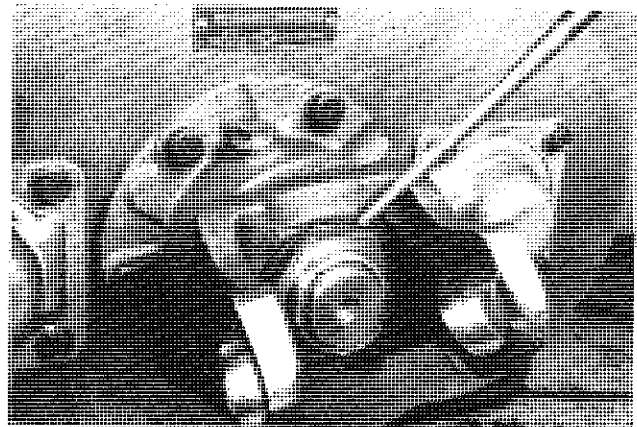

24. Torque output flange or yoke nut to 550-600 pounds feet.

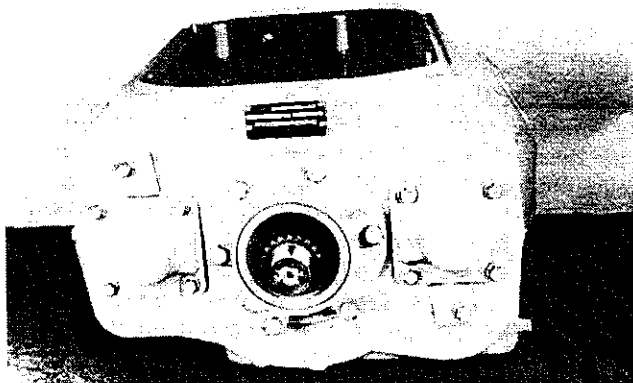

19. Place the output bearing cap on the case and secure with capscrews.

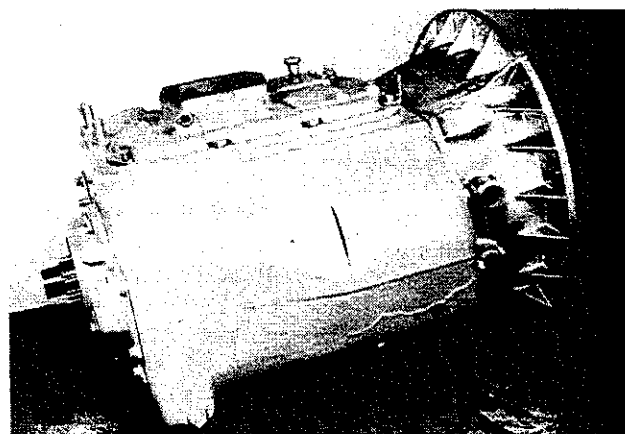

22. Place the shifter housing in its proper location and secure with capscrews.

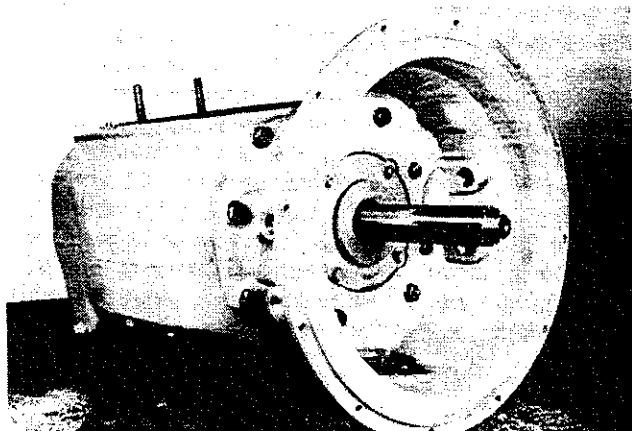

20. Assemble the clutch housing to the case.

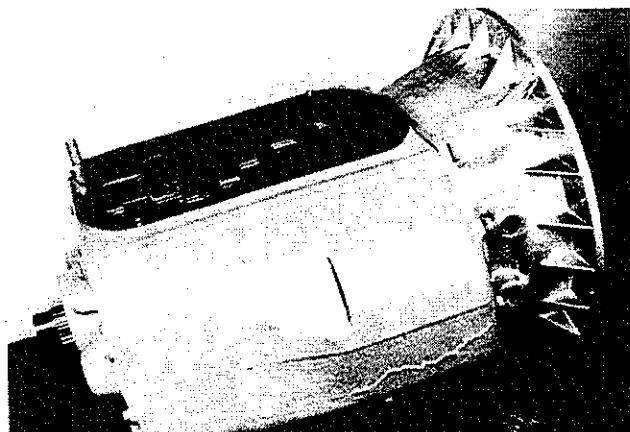

21. Shift all the clutch collars into the neutral position.

Important Procedure

When locating and correcting unit power or auxiliary transmission troubles, a systematic procedure should be followed.

Road test whenever possible. Mechanics usually get second or third hand reports of trouble experienced with the unit and these reports do not always accurately describe the actual conditions. Sometimes symptoms seem to indicate trouble in the transmission; while, actually the trouble may be caused by the axle, propeller shaft, universal joint, engine or clutch. This is especially true of complaints on noise. Therefore, before removing transmission or related components to locate trouble, always road test to check possibility that trouble may exist in other closely associated units. If the mechanic can drive, road testing will be more effective; however, just riding with the driver can be very informative.

Check Functioning Prior to Disassembly

If remote controls are used, a careful check of the remote and connecting linkage to transmission must be made. The remote unit must be in good working order if the transmission is expected to shift satisfactorily.

Many times the answer to the trouble is apparent when the unit is inspected prior to disassembly, but this evidence is often lost when the parts are separated. If possible, check the unit prior to disassembly. Bear in mind that a careful inspection of the unit should be made as each disassembly step is performed.

Inspect Thoroughly During Disassembly

It is poor practice to disassemble a unit or complete transmission as quickly as possible without bothering to examine the parts as they come down. It happens many times that a mechanic has completely disassembled a unit and failed to find the cause of the trouble because he did not bother to examine the parts as they came apart. After the transmission is disassembled, check the lubricant for foreign particles which often reveal sources of trouble that are overlooked during the disassembly.

Repair or Replace Worn Parts

Many times the parts or critical adjustments that have caused the trouble are not replaced or corrected because the mechanic will only inspect and replace parts that have failed completely. All pieces should be accurately examined because the broken parts are often just the result and not the cause of the trouble. All parts that are broken or worn and no longer meet specifications should be replaced. On large units, like a transmission, it is suggested that a mechanic replace parts that are worn to the extent that they do not have a long service life remaining. This avoids another teardown on the unit in the near future. It is also good practice, at this time, to make the changes or modifications recommended to bring the transmission up to date and increase the service life of the unit.

noisy Operation

Noise is usually very elusive and generally not the fault of the transmission; therefore, mechanics should road test to determine if the driver's complaint of noise is actually in the transmission.

In numerous instances, drivers have insisted that the noise was in the transmission, however, investigations revealed the noise to be caused by one of the following conditions:

- (a) Fan out of balance or blades were bent.
- (b) Defective vibration dampers.
- (c) Crankshafts out of balance.
- (d) Flywheels out of balance.
- (e) Flywheels mounting bolts loose.
- (f) Engine rough at idle producing rattle in gear train.
- (g) Clutch assembly out of balance.
- (h) Engine mounts loose or broken.
- (i) Power-take-off engaged.
- (j) Universal joints worn out.
- (k) Propeller shafts out of balance.
- (l) Universal joint angles out of plane or at excessive angle.
- (m) Center bearings in drive line dry, not mounted properly, etc.
- (n) Wheels out of balance.
- (o) Tire treads humming or vibrating at certain speeds.
- (p) Air leaks on suction side of induction system, especially with turbo-chargers.

Mechanics should try to locate and eliminate noise by means other than transmission removal, or overhaul. However, if the noise appears to be in the transmission try to break it down into the following classifications. If possible, determine what position the gear shift lever is in when the noise occurs. If the noise is evident in only one gear position, the cause of the noise is generally traceable to the gears in operation.

- (a) *Growl and humming* or, more serious, a grinding noise. These noises are caused by worn, chipped, rough or cracked gears. As gears continue to wear, the grinding noise will be noticeable, particularly in the gear position that throws the greatest load on the worn gear.
- (b) *Hissing* or, more serious, a thumping or bumping-type noise. Hissing noises can be caused by bad bearings. As bearings wear and retainers start to break up, etc., the noise could change to a thumping or bumping.

- (c) *Metallic rattles* within the transmission usually result from a variety of conditions. Engine torsional vibrations are transmitted to the transmission through the clutch. In heavy duty equipment, clutch discs with vibration dampers are not used, so a rattle, particularly in neutral, is common with diesel equipment. In general, engine speeds should be 600 RPM or above to eliminate objectionable rattles and vibration during the idle. A defective or faulty injector would cause a rough or lower idle speed and a rattle in the transmission. Rattle could also be caused by excessive backlash in P.T.O. unit mounting.
- (d) *Improper lubricants* or lack of lubricant can produce noises. Transmissions with low oil levels sometimes run hotter than normal, as there is insufficient lubricant to cool and cover the gears.

Improved highways permit sustained high speeds. The fact that engines and entire power trains can now cruise at a higher RPM can introduce vibration frequencies, that were not critical in the past. At slower speeds these items would get by or only pass through critical period while accelerating or decelerating through the gears.

In the past, drive line vibrations such as bent tubes, joints out of phase or alignment, bad angles to short couples, clutches out of balance, gears and shafts in transmission out of balance, were fairly obvious. These items will become more critical in vehicles running at sustained high speeds.

Critical vibrations associated with higher speeds are not the old thumping or bumping type but are high frequency vibrations which sting or tingle the soles of your feet, tickle the end of your fingers, etc. This type of vibration will cause gear seizures, broken synchronizer pins, bearing failure due to retainer rivet failures, promote brinelling, fretting corrosion, etc.

- (e) *Gear whine* is usually caused by lack of backlash between mating gears—improper shimming of P.T.O. units is the big offender here.

Noise in Neutral

Possible Causes:

- (a) Misalignment of transmission.
- (b) Worn flywheel pilot bearing.
- (c) Worn, or scored countershaft bearings.
- (d) Worn, or rough reverse idler gear.
- (e) Sprung, or worn countershaft.
- (f) Excessive backlash in gears.
- (g) Worn mainshaft pilot bearing.
- (h) Scuffed gear tooth contact surface.
- (i) Insufficient lubrication.
- (j) Use of incorrect grade of lubricant.

Noise in Gear

Possible Causes

- (a) Worn, or rough mainshaft rear bearing.
- (b) Rough, chipped, or tapered sliding gear teeth.
- (c) Noisy speedometer gears.
- (d) Excessive end play of mainshaft gears.
- (e) Refer to conditions listed under *Noise in Neutral*.

Oil Leaks

Possible Causes

- (a) Oil level too high.
- (b) Wrong lubricant in unit.
- (c) Non-shielded bearing used as front or rear bearing cap. (Where applicable.)
- (d) Seals (if used) defective or omitted from bearing cap, wrong type seal used, etc.
- (e) Transmission breather omitted, plugged internally, etc.
- (f) Capscrews loose, omitted or missing from remote control, shifter housing, bearing caps, P.T.O. or covers, etc.
- (g) Oil drain-back openings in bearing caps or case plugged with varnish, dirt, covered with gasket material, etc.
- (h) Broken gaskets, gaskets shifted or squeezed out of position, pieces still under bearing caps, clutch housing, P.T.O. and covers, etc.
- (i) Cracks or holes in castings.
- (j) Drain plug loose.
- (k) Also possibility that oil leakage could be from engine.
- (l) Speedometer adaptor or connections.

Walking or Jumping Out of Gear

If the units are walking out of gear it could be caused by:

- (a) Interference or resistance in the shift mechanism preventing full engagement of the sliding clutch gear or
- (b) If the gear has been shifted completely into position some other malfunction which could move the gear or the shift itself out of its proper location.

If remote controls are used, the mechanic must satisfy himself that the remote units are satisfactory and that transmission is actually at fault. One other point that should be noted is whether the unit walks out of gear under drive (while pulling a load) or on a coast load. Also, does the gear hop occur on smooth or only on rough roads. A number of items that would prevent full engagement of gears are:

- (a) Improperly positioned forward remote control which limits full travel forward and backward from the remote neutral position.
- (b) Improper length shift rods or linkage that limits travel of forward remote from neutral position.
- (c) Loose bell cranks, sloppy ball and socket joints.
- (d) Shift rods, cables, etc., too spongy, flexible, or not secured properly at both ends.
- (e) Worn or loose engine mounts if forward unit is mounted to frame.
- (f) Forward remote mount too flimsy, loose on frame, etc.
- (g) Set screws loose at remote control joints or on shift forks inside remote or even inside transmission unit.
- (h) Shift fork pads or groove in sliding gear or collar worn excessively.
- (i) Worn taper on gear clutch teeth.
- (j) Transmission and engine out of alignment either vertically or horizontally.

A few items which could move the gear or shaft out of proper position, particularly on rough roads are:

- (a) Use of heavy shift lever extensions.
- (b) Shift rod poppet springs broken.
- (c) Shift rod poppet notches worn.
- (d) Shift rod bent or sprung out of line.
- (e) Shift fork pads not square with shift rod bore.
- (f) Excessive end-play in drive gear, mainshaft or countershaft, caused by worn bearings, retainers, etc.
- (g) Thrust washers worn excessively or missing.

Clutch Shifting

An improperly operating clutch will interfere with the proper shifting of gears in any transmission. It is important that the hydraulic, air or similar release mechanism (if used), also be used in proper working order. If the mechanic is sure that a full and complete clutch release is being made, the following could be a few of the possible causes for hard shifting complaints:

- (a) No lubricant in remote control units. Forward remote is isolated and is often overlooked. However, many remote controls used on transmissions and auxiliaries require separate lubrication.
- (b) No lubricant in (or grease fittings on) U-joints or swivels of remote controls.
- (c) Lack of lubricant or wrong lubricant used, causing buildup of sticky varnish and sludge deposits on splines of shaft and gears.
- (d) Badly worn or bent shift rods.
- (e) Improper adjustment on shifter linkage.
- (f) Sliding clutch gears tight on splines of shaft.
- (g) Clutch teeth burred over, chipped or badly mutilated due to improper shifting.
- (h) Binding or interference of shift lever with other objects or rods inside the cab or near the remote control island.
- (i) Driver not familiar with proper shifting procedure for this transmission. Also includes proper shifting if used with 2-speed axle, auxiliary, etc.
- (j) Clutch or drive gear pilot bearing seized, rough, or dragging.
- (k) Clutch brake engaging too soon when clutch pedal is depressed.
- (l) Wrong lubricant especially if E.P. type lubricant are added.
- (m) Free running gears, seized or galled on either the thrust face or diameters.

Sticking in Gear

- (a) Clutch not releasing—also check remote units such as hydraulic or air assist, etc. Note: On some units employing a full air control for clutch release, air pressure of approximately 60 lbs. or more must be secured before clutch can be released. *Do not leave these vehicles parked in gear.*
- (b) Sliding clutch gears tight on splines.
- (c) Chips wedged between or under splines of shaft and gear.
- (d) Improper adjustment excessive wear or lost motion in shifter linkage.
- (e) Clutch brake set too high on clutch pedal—locking gears behind hopping guard.

Bearing Failures

The service life of most transmissions either main or auxiliaries is governed by the life of the bearings. Majority of bearing failures can be attributed to vibration and dirt. Some of the more prominent reasons for unit removal with bearing failures are:

- (a) Worn out due to dirt.
- (b) Fatigue of raceways or balls.
- (c) Wrong type or grade of lubricant.
- (d) Lack of lubricant.
- (e) Vibrations—breakup of retainer & brinelling of races—fretting corrosion.
- (f) Bearings tied-up due to chips in bearings.
- (g) Bearings set-up too tight or too loose.
- (h) Improper assembly—brinelling bearing.
- (i) Improper fit of shafts or bore.
- (j) Acid etch of bearings due to water in lube.
- (k) Overloading of vehicle. Overload from engine or engine too large for transmissions used.

Dirt

More than 90% of all ball bearing failures are caused by dirt which is always abrasive.

Dirt may enter the bearings during assembly of the units or be carried into the bearing by the lubricant while in service. Dirt may enter through seals, breather or even dirty containers used for addition or change of lubricant.

Softer material such as dirt, dust, etc., usually forms abrasive paste or lapping compounds within the bearings themselves since the unit pressure between the balls and raceways makes a perfect pulverizer. The rolling motion tends to entrap and hold the abrasives. As the balls and raceways wear, the bearings become noisy. The lapping action tends to increase rapidly as the fine steel from the balls and rollway adds to the lapping material.

Hard coarse materials such as chips, etc., may enter the bearings during assembly from hammers, drifts, power chisels, etc., or be manufactured within the unit during service from raking teeth, etc. These chips produce small indentation in balls and races. Jamming of these hard particles between balls and races may cause the inner face to turn on shaft, or the outer race to turn in the housing.

Fatigue

All bearings are subject to fatigue and must be replaced eventually. Your own operating experience will dictate mileage replacement of bearings showing only normal wear.

Corrosion

Water, acid and corrosive materials formed by deterioration of lubricant, will produce reddish-brown coating and small etched holes over outer and exposed surfaces of race. Corrosive oxides also act as lapping agent.

Brinelling caused by improper assembly or removal—usually hammering with off-center blows. Use drivers, preferably under an arbor, or pullers.

Shaft Fits

Excessive looseness under load is very objectionable because it produces a creeping or slipping of the inner ring on the rotating shaft. This causes the surface metal of shafts to scrub or wear off.

Bearing fits on rotating shafts are usually specified as tight. When play or looseness, even .001", exists between the bearing and shaft, there is a very powerful force tending to rotate the inner race on the shaft; this force is caused by the looseness or lost motion between the parts and disappears when no looseness exists.

Removal of Bearings

It is far more difficult to remove bearings from a shaft than to put them on. In most cases it is necessary to remove the bearing by pulling on the outer-race which can damage the balls or races. Since such damage is seldom visible, it does not become known until after complete reassembly. It is good preventative maintenance to replace most ball bearings during the overhaul period. If a bearing is not going to be replaced, avoid removal during low mileage rebuild.

Interchangeability

All ball bearings (whether manufactured here or abroad) are interchangeable in regard to—standardized dimensions, tolerances and fits. However, for a given shaft size there are standard bearings for light, medium, and heavy-duty service.

Numbers and symbols stamped on inner and outer races of bearings designate size and type.

Numbering systems of different bearing manufacturers, however, have not been standardized. Consult interchangeable tables and use proper bearings for replacement parts.

Clutch Trouble Shooting

Faulty clutch operation interferes with proper shifting of gears in any transmission. For complete information on Spicer Heavy Duty Clutches, refer to Bulletins No. 1302 and 1303. If a clutch other than a Spicer is used with this transmission, refer to the manufacturer's service manual for correct adjustment, maintenance, etc. The two following paragraphs describe the most common problems encountered with Spicer clutches.

- (a) If the clutch slips or does not engage properly, first check the internal clutch adjustment. If adjustment does not remedy the situation, check for weak pressure springs, no free pedal, worn or oily clutch facings and binding release mechanism.
- (b) If the clutch drags or does not release properly, check the internal clutch adjustment. Some other causes for clutch drag are: intermediate plate sticking on drive pins or drive lugs; pressure plate not retracting; driven disc distorted or warped; splines worn on main drive gear of transmission; clutch release bearing damaged; bushing in release sleeve dragging on transmission drive gear.

NOTE

See Transmission Installation Section of clutch manual for information on making the internal clutch adjustment to Spicer Heavy Duty Clutches.

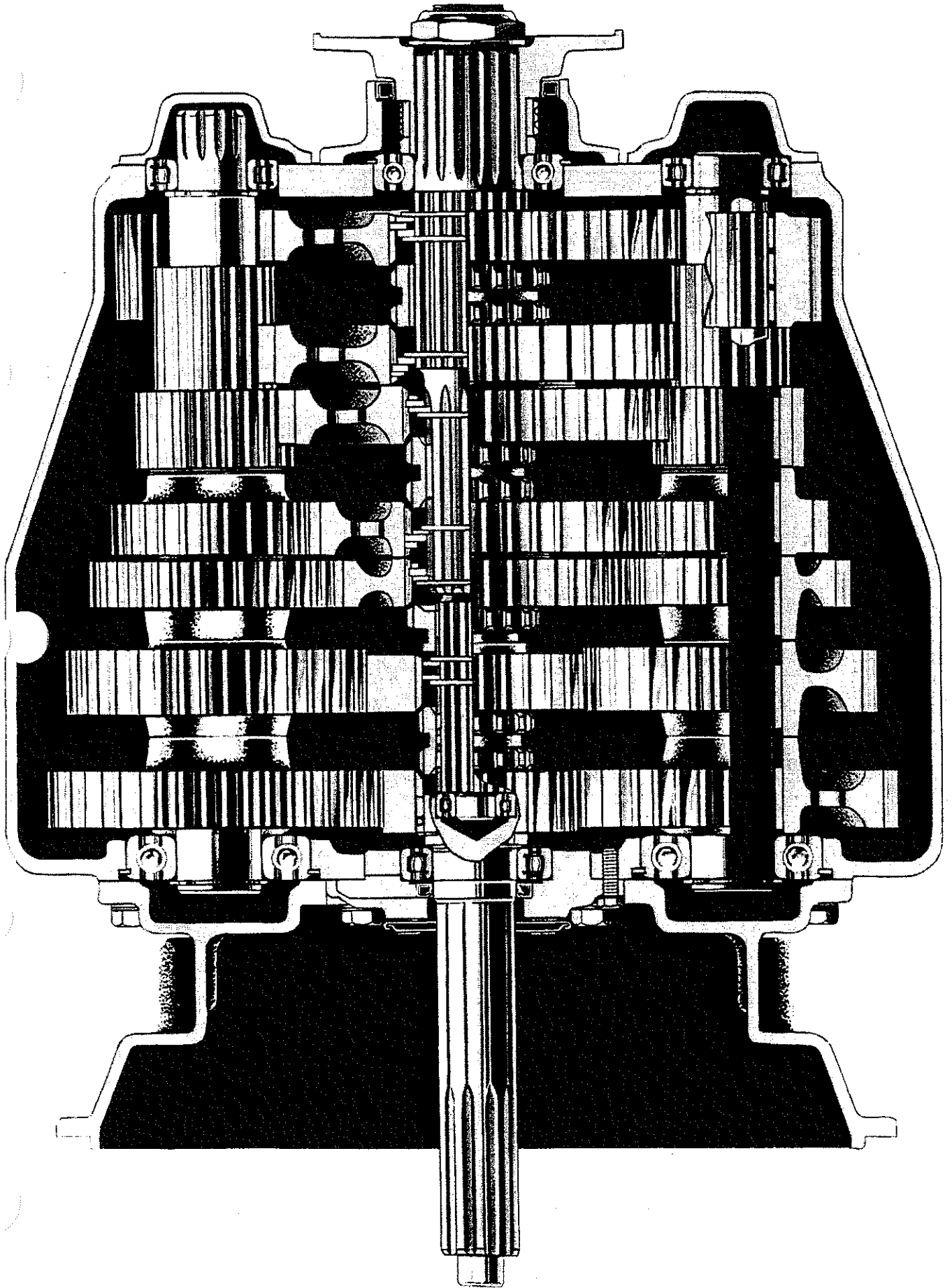

SPICER MODELS PS130-6B & 1362



14700 Helm Court
Plymouth, MI 48170
(800) 401-9866 or (734) 456-3770
Fax: (734) 456-3739
www.ttcautomotive.com

